

ICOM

INSTRUCTION MANUAL

COMMUNICATIONS RECEIVER **IC-R100**



Icom Inc.

IMPORTANT

READ ALL INSTRUCTIONS carefully and completely before using the receiver.

SAVE THIS INSTRUCTION MANUAL — This instruction manual contains important safety and operating instructions for the IC-R100.

FOREWORD

Thank you for purchasing Icom's **IC-R100 COMMUNICATIONS RECEIVER**. An advanced wideband receiver, the IC-R100 has the following features:

- Wideband frequency coverage 0.1 ~ 1856 MHz* continuously with FM, AM and Wide FM modes.
*Guaranteed range: 0.5 ~ 1800 MHz. Some versions are restricted within certain frequency ranges.
- Compact size for mobile operation capability.
- Multiple scan functions including auto memory write scan.
- 24-hour clock system with multiple timer functions.
- A variety of tuning steps corresponding to any operating band.

CAUTIONS

WARNING! When you hear lightning while using an outside antenna, disconnect the antenna connectors and the AC adapter or AC power cable from the AC outlet.

NEVER connect a non-recommended AC adapter. This may result in a fire hazard or electric shock.

NEVER allow children to touch the receiver.

AVOID placing the receiver in direct sunlight, such as on the dashboard.

OPERATING NOTES

Information overheard but not intended for you cannot lawfully be used in any way.

The IC-R100 may receive its own oscillated frequency resulting in no reception or noise-only reception on some frequencies.

When an excessively strong signal is received, for example a signal transmitting within 1 m, the receiver may malfunction. Use an attenuator in this case.

TABLE OF CONTENTS

IMPORTANT	i
FOREWORD	i
CAUTIONS	i
OPERATING NOTES	i
TABLE OF CONTENTS	ii
UNPACKING	ii
1 PANEL DESCRIPTION	1
2 INSTALLATIONS	5
3 FREQUENCY SETTING	9
4 RECEIVING	11
5 MEMORY CHANNEL	12
6 SCAN OPERATION	15
7 CLOCK & TIMER	20
8 MAINTENANCE	25
9 SPECIFICATIONS	27
10 OPTIONS	28

UNPACKING

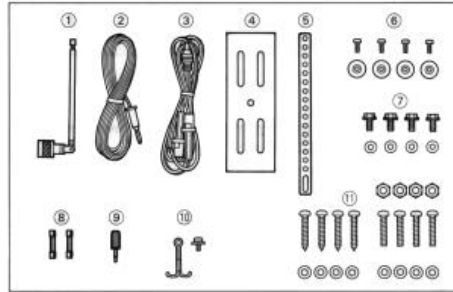

Accessories included with the IC-R100:

- | | |
|---|---|
| ① VHF/UHF telescoping antenna | ⑨ Speaker plug (AP-313) |
| ② HF wire antenna (OPC-069) | ⑩ Cable tie and set screw (C3 x 6) |
| ③ DC power cable (OPC-131) | ⑪ Mounting screw set
(MS x 20 screws,
B0 MS x 20 screws,
M5 nuts, M5 flat washers,
M5 spring washers) |
| ④ Mounting bracket | |
| ⑤ Mounting support bracket | |
| ⑥ Rubber feet and screws (M2.6 x 6) | |
| ⑦ Bracket bolts and M4 flat washers (4 pcs) | |
| ⑧ Fuses (FGB 2 A; 2 pcs) | |

1 PANEL DESCRIPTION

■ Front panel

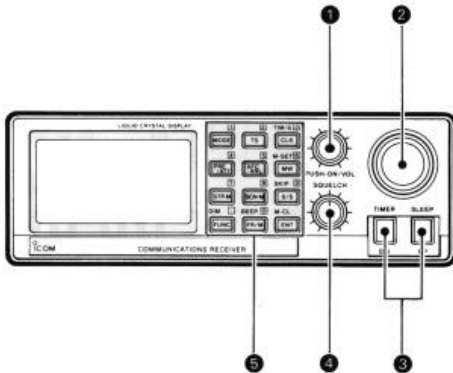

- POWER SWITCH/VOLUME CONTROL [PUSH-ON/VOL]** (p. 9)
Turns power ON and OFF when pushing the control.
Adjusts the audio output level when rotating the control.
- TUNING CONTROL** (p. 9)
Sets the frequency or memory channel. The [FR/M] key sets the tuning control for frequency or memory channel changes.
- UP/DOWN SWITCHES [UP]/[DN]**
Change the frequency or memory channel.
Activate the clock timer or sleep timer after pushing [FUNC].
- SQUELCH CONTROL [SQUELCH]**
Sets the squelch threshold level. Rotate this control clockwise to cut noise and weak signals.

5 KEYBOARD

	When the frequency and memory channels appear.			When the frequency and memory channels disappear (after pushing [ENT].)
	When [F] disappears for primary functions.		When [3] appears (after pushing [FUNC]) for secondary functions.	
MODE	Selects FM, WFM or AM.	p. 11	—	—
TS	Selects a tuning step.	p. 9	—	—
TIME/CLK	Displays time in 24-hour system.	p. 20	Enters CLOCK mode.	p. 20

1 PANEL DESCRIPTION

Function display



- 6 **FUNCTION INDICATOR**
Appears when the [FUNC] key is pushed.
• Disappears when no switch is pushed for 5 sec.
- 7 **MODE INDICATORS** (p. 11)
Indicate the receive mode.
- 8 **AFC/ANL INDICATORS** (p. 11)
Appear when the AFC (Automatic Frequency Control) or ANL (Automatic Noise Limiter) function is activated.
- 9 **TUNING STEP INDICATORS** (p. 9)
Indicate the selected tuning step increment.

- 10 **S-INDICATOR** (p. 11)
Shows the relative received signal strength.
- 11 **MEMORY INDICATOR** (p. 12)
Appears when MEMORY mode is selected and disappears when FREQUENCY mode is selected.
• The [FR/M] key turns ON/OFF the indicator.
- 12 **SKIP INDICATOR** (p. 19)
Appears when the memory channel is set as the skip channel.
- 13 **MEMORY CHANNEL READOUT** (p. 12)
Shows the selected memory channel number.
- 14 **TIMER INDICATOR** (p. 22)
Appears when a timer function is activated.
- 15 **SCAN TYPE INDICATORS** (p. 15)
Indicate the selected scan type.
- 16 **SCAN RESUME INDICATORS** (p. 17)
Indicate the selected scan resume condition.
- 17 **PREAMP/ATTENUATOR INDICATORS** (p. 11)
Appear when the preamp or attenuator is activated.

Rear panel

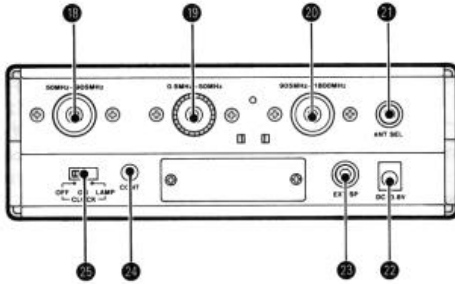

- 18 **ANTENNA CONNECTOR [50MHz ~ 905MHz]** (p. 7)
Connects to the supplied telescoping antenna or a 50 ~ 1000 MHz wideband antenna to suit your need with a Type-N connector.
- 19 **ANTENNA CONNECTOR [0.5MHz ~ 50MHz]** (p. 7)
Connects to the supplied wire antenna or 0.5 ~ 50 MHz antenna to suit your need with PL-259 connector.

- 20 **ANTENNA CONNECTOR [905MHz ~ 1800MHz]** (p. 7)
Connects to the supplied telescoping antenna or a 900 ~ 1800 MHz antenna to suit your need with a Type-N connector.
- 21 **ANTENNA SELECTOR JACK [ANT SEL]**
Outputs voltage corresponding to the selected band.
 - An external antenna selector may be used with this output voltage.
- 22 **DC POWER JACK [DC13.8V]** (p. 5)
Accepts 13.8 V DC using the supplied DC power cable.
- 23 **EXTERNAL SPEAKER JACK [EXT SP]**
Accepts a 4 ~ 8 Ω speaker for connection.
- 24 **CONTRAST POT [CONT]** (p. 10)
Adjusts the LCD contrast.
- 25 **CLOCK SELECTOR SWITCH [CLOCK]** (p. 5)
Selects the function display indication when the power is OFF.
 - “LAMP” : Clock time with backlight is displayed.
 - “ON” : Clock time without backlight is displayed.
 - “OFF” : No clock time is displayed.

2 INSTALLATIONS

Power connection

CAUTION: NEVER connect the receiver directly to a 24 V battery.

IC-R100 rear panel

CABLE TIE
Use the supplied cable tie to prevent the power cable from accidentally becoming unplugged.

IN YOUR VEHICLE

BE CAREFUL! Set the [CLOCK] switch on the rear panel to “OFF” when directly connecting to a 12 V battery. When [CLOCK] is set at “LAMP” or “ON,” the receiver consumes some electricity even if the power is OFF.

CP-11 (optional)

IN YOUR HOME

An optional AD-15A/E/D/V AC ADAPTER is available for AC operation

AD-15A/E/D/V (optional)

USING AN EXTERNAL AC POWER SUPPLY

Connect to a 13.8 V DC power source using the supplied DC power cable.

AC power supply

Supplied DC power cable

⊕white ⊖black Fuse (FGB 2 A)

■ Mobile installation

Select a location which can support the weight of the receiver and does not interfere with driving in any way.

CAUTION: NEVER place the receiver where normal operation of the vehicle may be hindered or where it could cause bodily injury.
DO NOT place the receiver where large temperature changes.

• Location samples in vehicle

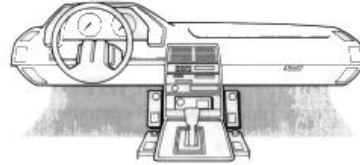

• Using the mounting bracket

- 1) Drill four holes where the mounting bracket is to be installed.
 - Hole sizes:
 approx. 5.5 – 6 mm when using nuts.
 approx. 2 – 3 mm when using self-tapping screws.
- 2) Insert the supplied screws, nuts and washers through the mounting bracket and tighten.
- 3) The supplied mounting support bracket may be helpful in tightening installation.
- 4) Adjust the angle for the clearest view of the function display.

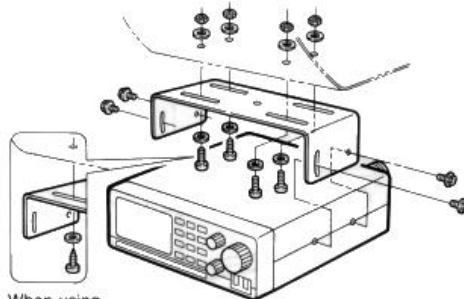

When using self-tapping screws.

2 INSTALLATIONS

■ Home installation

Attach 4 rubber stands to the bottom of the receiver when no external speaker is connected. Audio from the internal speaker will be more clearly output.

Keep away from extreme heat, cold, vibrations, TV sets, TV antenna elements, radios, personal computers and electromagnetic sources.

• Attaching rubber stands

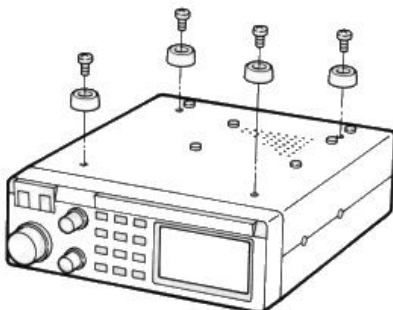

■ Antenna

For optimum receiver operation, antennas are one of the important factors along with sensitivity. The supplied antenna may give you enough sensitivity. However, some frequencies may not be received depending on the operating location, receiving band, etc. A high-grade antenna will give you more efficient reception.

DISCONE ANTENNA
 (VHF/UHF band omnidirectional)

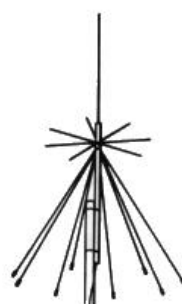

An optional AH-7000 is available from Icom.

LOG PERIODIC ANTENNA
 (VHF/UHF band directional)



LONG WIRE
 (HF band)



Use the supplied long wire antenna.

■ Antenna connector

• PL-259 connector

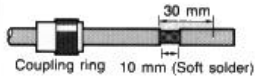

Slide the coupling ring. Strip the cable jacket and soft solder.

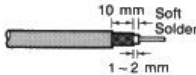

Strip the cable as shown at left. Soft solder the center conductor.

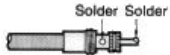

Slide the connector body and solder it.



Screw the coupling ring onto the connector body.
(10 mm = 3/8 inch)

• Type-N connector

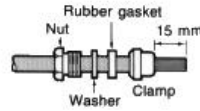

Slide parts as shown at left. Cut the end of the cable evenly.



Strip the cable and fold the braid over the clamp. Evenly trim the braid ends.

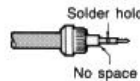

Soft solder the center conductor. Install the pin and solder it.

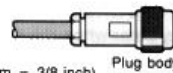

Slide the plug body and tighten the nut.
(10 mm = 3/8 inch)

8

3 FREQUENCY SETTING

■ Before setting

Be sure the [DC13.8V] jack and antennas are properly connected before turning ON power. See pgs. 5~8 for connection details.

After confirming, push the [VOL] control to turn ON power.

• FREQUENCY mode

When setting the frequency, be sure the **[M]** indicator disappears. The [FR/M] key turns off the indicator.



[M] disappears.
When **[M]** appears, push [FR/M].

NOTE: The set frequency may clear when the memory channel is changed. To keep the set frequency, push and hold the [MW] key.

■ Setting operation

IMPORTANT: When no frequency appears on the function display, proceed "Using the keyboard" (p. 10) first.

• Using the tuning control

- 1) Push [FR/M] to turn off the **[M]** indicator.
- 2) Rotate the tuning control to set the frequency.
 - To set the tuning steps, see below, if desired.

• Using the [UP]/[DN] switches

- 1) Push [FR/M] to turn off the **[M]** indicator.
- 2) Push the [UP] or [DN] switch to change the frequency.
 - Holding the switch allows the frequency to change continuously

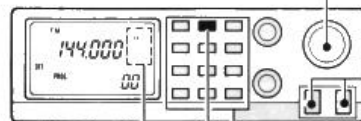

• Setting the tuning step

- 1k 10k
- 5k 12.5k
- 8k 20k
- 9k 25k

Push [TS] to select the desired tuning step.

Some steps cannot be selected depending on the selected frequency band.

7

• **Using the keyboard**

- 1) Push [FR/M] to turn off the  indicator.
- 2) Push [ENT].
 - When a frequency is displayed, it disappears.
- 3) Enter the desired frequency using the digit key.
 - Enter [.] between the 1 MHz and 100 kHz units, and between 1 kHz and 500 Hz units.
 - If a wrong frequency is entered, push [ENT] twice and enter again.
- 4) Push [ENT] to store the entered frequency.

[EXAMPLE]

144.00 MHz → [ENT][1][4][4][ENT]

144.56 MHz → [ENT][1][4][4][.][5][6][ENT]

0.16 MHz → [ENT][0][.][1][6][ENT]
(160 kHz)

2.0625 MHz → [ENT][2][.] [0][6][2][.] [5][ENT]
(2062.5 kHz)

[6] - [9] can be used for
0.5 kHz input instead of [5].

• **5 sec. timer**

The [FUNC] and [ENT] key functions are automatically canceled when no switch is pushed for 5 sec.

CONVENIENT

• **Beep tone**

Push [FUNC] then push [FR/M] to turn the beep tone ON and OFF. You can select silent operation or confirmation operation.

• **Dimmer function**

Push [FUNC] twice to dim the display backlight. Dark backlighting may prevent your eyes from tiring during night operation.

To return to the normal backlighting, push [FUNC] twice again.

• **Display contrast**

Character contrast on the function display can be adjusted lighter or darker for ease of viewing. Adjust the [CONT] pot on the rear panel using a screw driver.

4 RECEIVING

■ **Basic receiving**

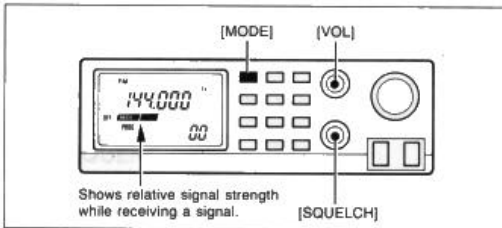

- 1) Push the [VOL] control to turn power ON.
- 2) Turn [SQUELCH] fully counterclockwise.
- 3) Adjust [VOL] to the desired audio level.
- 4) Rotate [SQUELCH] clockwise for audio mute while no signal is received.
- 5) Push [MODE] to select the desired receive mode.
 - See right above for mode information.
- 6) Set the desired frequency.
 - See the frequency setting on p. 9 for details.

• **Receive mode**

Push [MODE] to select the desired receive mode.

MODE	STATION EXAMPLE
FM	Business band, Marine band, Amateur band, etc.
WFM (Wide FM)	TV band, FM broadcasting, etc.
AM	Broadcasting, Air band, Citizen band, etc.

WHEN THE WRONG MODE IS SELECTED

- Audio distorts.
- Only noise can be heard.
- Small audio and large noise interference.
- S-indicator instability showing signal strength.

■ **Efficient receiving**

AFC (Auto Frequency Control) In FM mode

Push [AFC:ANL] to activate the AFC function. The AFC function automatically adjusts the receive frequency to the signal center for clear and stable receiving.

NOTE: The AFC function activates above 50 MHz.

ANL (Auto Noise Limiter) In AM mode

Push [AFC:ANL] to activate the ANL function. The ANL function reduces noise components for clear reception.

PREAMP AND ATTENUATOR

Push [PRE/ATT] once for preamp activating.

- A weak signal can be heard clearly.
- The preamp activates at 50 ~ 905 MHz only.

Push [PRE/ATT] twice for attenuator activating.

- A strong signal can be heard without distortion.

Memory channel outline

The IC-R100 has 100 memory channels, 20 programmable scan edge channels and 1 priority scan channel. Each memory channel stores frequency, mode, tuning step and preamp/attenuator information, and has the following special functions. These memory channels are very useful for quick changing to a desired frequency.

MEMORY CHANNEL NUMBER	CAPABILITY
00 ~ 79	<ul style="list-style-type: none"> Each channel stores frequency, mode, tuning step and preamp/attenuator informations. Each channel can be set as a memory skip channel and a frequency skip function. Memory channels 10 ~ 79 are blank when you purchase the receiver.
80 ~ 99	<ul style="list-style-type: none"> The same information as above can be programmed. Used as the memory writing space for the auto memory write scan. Memorized contents will be cleared when starting the auto memory write scan.
P0A ~ P9B	<ul style="list-style-type: none"> Used as the programmed scan edges. Each channel stores frequency, mode, tuning step and preamp/attenuator informations.
P-P	<ul style="list-style-type: none"> Used as the priority channel for the priority scan. Stores frequency, mode, tuning step and preamp/attenuator informations.

Memory channel selection

Using the tuning control

- 1) Push [FR/M] to light up the **M** indicator.
- 2) Rotate the tuning control to select a memory channel.
 - [UP]/[DN] can also be used.

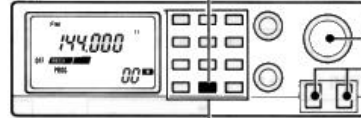

Using the keyboard

- 1) Be sure **M** lights.
- 2) Push [ENT].
- 3) Enter the memory channel number using digit keys.
- 4) Push [ENT].

NOTE: Memory channels P0A ~ P9b and P-P cannot be selected with the keyboard.

[EXAMPLE]

Selecting Mch 79.
Push [ENT][7][9][ENT].

5 MEMORY CHANNEL

Memory writing

Each memory channel has frequency, mode, tuning step and preamplifier/attenuator programming capability.

- 1) Push [FR/M] to light up the **M** indicator.
- 2) Rotate the tuning control to select the desired memory channel.
 - The [UP]/[DN] switches and keyboard can also be used.
- 3) Push [FR/M] to turn off the **M** indicator.
- 4) Set the frequency, mode and tuning step.
 - Frequency setting → See p. 9
 - Mode setting → See p. 11
 - Tuning step setting → See p. 9
- 5) Push and hold the [MW] key for 2 sec.
 - 3 beeps alert you that the contents are programmed.

[EXAMPLE] Writing 101.75 MHz/WFM into memory channel 8.

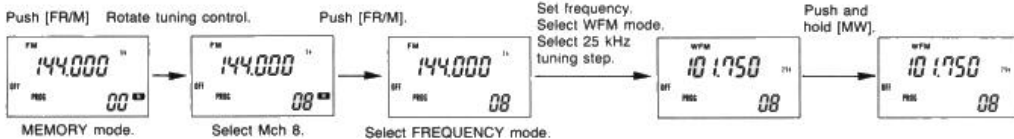

[EXAMPLE] Writing 163.00 MHz/FM into memory channel P2b (scan edge channel).

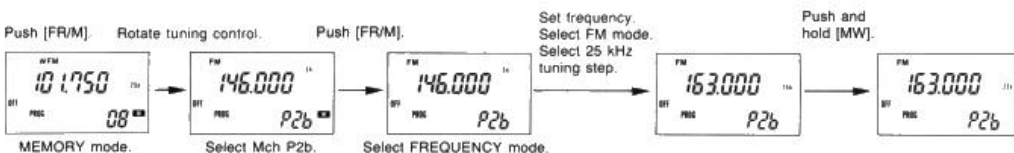

■ Channel number change

The memory channel number only can be changed while keeping the displayed frequency. This function is useful when you wish to memorize the displayed frequency into a memory channel that is not displayed or when you wish to copy the memory contents to another memory channel.

- 1) Push [FR/M] to light up the **M** indicator.
- 2) Push [FUNC].
- 3) While pushing [MW], rotate the tuning control to select the desired memory channel.
- 4) Release [MW] and then push and hold [MW] for 2 sec.
 - If [MW] is not pushed, the displayed frequency will clear when you change the memory channel.

■ Memory clearing

Unwanted memory channel contents can be cleared.

- 1) Push [FR/M] to light up the **M** indicator.
- 2) Rotate the tuning control to select the desired memory channel to be cleared.
 - The [UP]/[DN] switches and keyboard can also be used.
- 3) Push [FUNC] and then push and hold [ENT] for 2 sec.
 - Displayed frequency disappears from the function display.

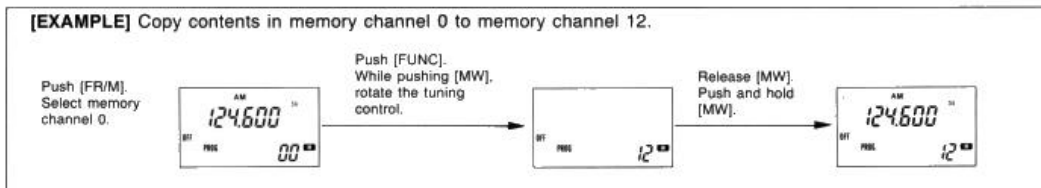

14

6 SCAN OPERATION

■ Selecting a scan

The scan function automatically scans signals in the specified frequency range or in the memory channels. The IC-R100 has 9 scan types to fit your signal searching needs.

Push [SCN-M] to repeatedly select the desired scan type.

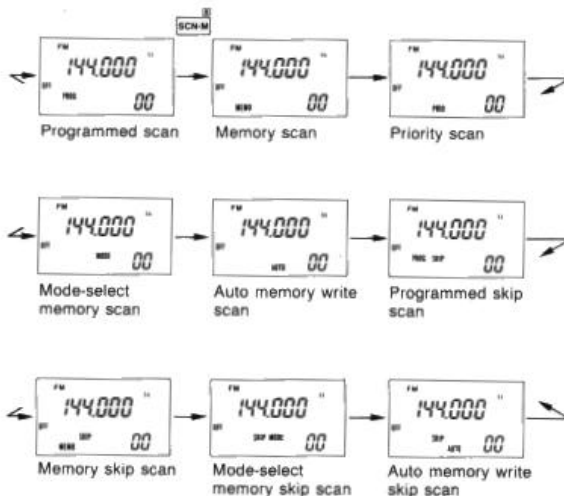

■ Scan types

• Programmed scan

Repeatedly scans between two programmable frequencies. The receiver has 10 groups of scanning ranges (20 edge frequencies).

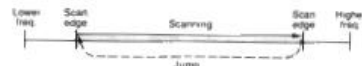

• Mode-select memory scan

Repeatedly scans memory channels with the same selected receive mode.

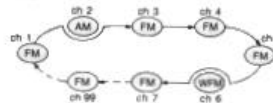

• Memory skip scan

Skips programmed memory channels during memory scan.

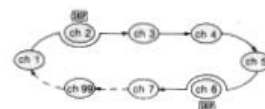

• Memory scan

Repeatedly scans all memory channels in sequence except blanked memory channels.

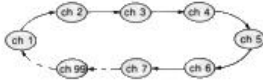

• Priority scan

Watches memory channel P-P at 5 sec. intervals. The tuning control can be used even while scanning.



• Auto memory write scan

Automatically programs the received frequency into memory channels 80 ~ 99 during programmed scan.

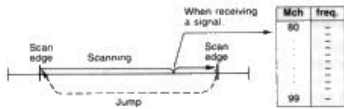

• Programmed skip scan

Skip programmed frequencies during programmed scan. Memory channels 79~0 are used for skip frequency programming.

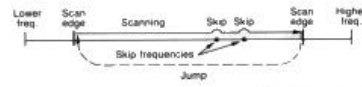

• Mode-select memory skip scan

Skips programmed memory channels during mode-select memory scan.

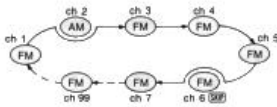

• Auto memory write skip scan

Skips programmed frequencies during auto memory write scan.

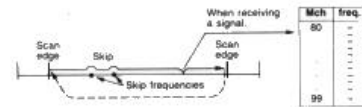

6 SCAN OPERATION

■ Scan resume condition

The scan pauses when it finds a signal, and then resumes or is canceled depending on the selectable scan resume condition. The receiver has 3 types of scan resume conditions for a wide variety of scanning possibilities.

Push [STP-M] to select the desired resume condition.

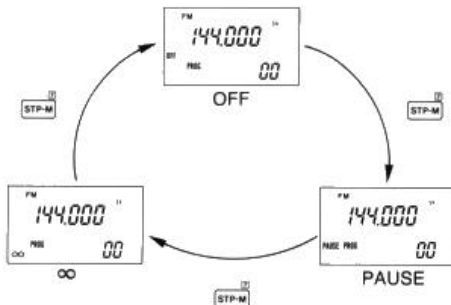

• OFF

Scan pauses while receiving a signal and resumes approx. 2 sec. after the signal disappears.

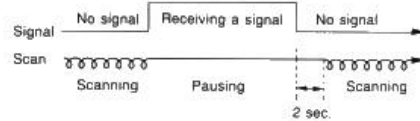

• PAUSE

Scan pauses for 5 sec. and resumes even when the signal continues.

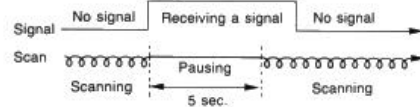

• ∞

Scan is canceled when a signal is received and the receiver stays on the frequency that the scan stopped.

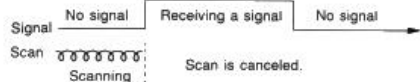

■ Scan operation

NOTE: Set the squelch to the threshold point when operating the scan.

SCAN TYPE	SCAN INDICATOR (Push [SCN-M] to select.)	REQUIRED PRE-OPERATION	SCAN START	SCAN STOP
PROGRAMMED SCAN	PROG	Set the scan edge frequencies. (p. 19) Up to 10 groups of scan edges can be programmed.	Push [S/S] then push a group number, [0] – [9].	Push [S/S]
PROGRAMMED SKIP SCAN	PROG SKIP	Set the scan edge frequencies. Program the skip frequencies while scanning (p. 19)		
MEMORY SCAN	MEMO	Program the desired frequencies into memory channels. (p. 13)	Push [S/S].	
MEMORY SKIP SCAN	MEMO SKIP	Program the desired frequencies into memory channels and set undesired memory channels as the skip channels. (p. 19)		
MODE-SELECT MEMORY SCAN	MODE	Program the desired frequencies into memory channels. At least 2 memory channels programmed in the same mode are necessary.	Push [MODE] to select the desired mode, then push [S/S].	
MODE-SELECT MEMORY SKIP SCAN	SKIP MODE	Same as the mode-select memory scan. Set undesired memory channels as the skip channels. (p. 19)		
PRIORITY SCAN	PRIO	Program the priority watch frequency into memory channel P- P. (p. 13)	Push [S/S].	
AUTO MEMORY WRITE SCAN	AUTO	Set the scan edge frequencies (p. 19) Set the scan pause condition as "PAUSE." (p. 17) CAUTION: The contents in memory channels 80 – 99 are cleared when the scan is started.	Push [S/S] then push a group number, [0] – [9].	Automati- cally stops if the scan writes fre- quencies up to the memory channel 99.
AUTO MEMORY WRITE SKIP SCAN	SKIP AUTO	Same as the auto memory write scan. Program the undesired frequencies using programmed skip scan. (p. 19)		

18

6 SCAN OPERATION

CONVENIENT

• During scan operation

The following conditions can be changed during scan operation:

- Scan direction (Push [UP] or [DN].)
- Receive mode (Push [MODE].)
- Tuning step (Push [TS].)
- Scan resume condition (Push [STP-M].)
- Preamplifier or attenuator (Push [PRE/ATT].)
- AFC or ANL function (Push [AFC-ANL].)
- Tuning control also stops a scan (except priority scan).

• Memory skip channel

MEMORY SKIP SCAN
MODE-SELECT MEMORY SKIP SCAN

- 1) Push [FR/M] to light up the **M** indicator.
- 2) Select the required memory channel to be skipped using the tuning control, [UP]/[DN] or keyboard.
- 3) Push [FUNC], then push [S/S] to light up or turn off the **SKIP** indicator.
 - The **SKIP** shows that the selected channel is set as the skip channel.



Skip appears on a skip channel.

• Scan edge programming

PROGRAMMED SCAN
PROGRAMMED SKIP SCAN
AUTO MEMORY WRITE SCAN
AUTO MEMORY WRITE SKIP SCAN

The receiver has 10 groups of scan edge channels, P0A/P0b ~ P9A/P9b. Program the scan edge frequencies into each group the same way as with memory writing. See p. 13 for programming details.

- 1) Push [FR/M] to light the **M** indicator, then select a memory channel in P0A – P9A using the tuning control.
 - The keyboard cannot be used to select directly.
- 2) Push [FR/M] to turn off the **M** indicator, then set the desired frequency, mode and tuning step.
- 3) Push and hold [MW] for 2 sec. for programming.
- 4) Repeat steps 1 – 4 above to program the other edge of channel P0b ~ P9b.
 - Program into the same group such as P0b when programming the frequency into P0A in step 4.

• Skip frequency programming

PROGRAMMED SKIP SCAN
AUTO MEMORY WRITE SKIP SCAN

- 1) Start programmed skip or auto memory write skip scan:
 - Select the "PROG SKIP" or "AUTO SKIP" indicator using [SCN-M].
 - Select the "OFF" or "PAUSE" indicator using [STP-M].
 - Push [S/S].
- 2) When receiving an undesired signal, push and hold [MW] for 2 sec.
 - The frequency is programmed into memory channel 79 as the skip frequency.
 - Undesired frequencies can be programmed into memory channels 79 – 0.

CLOCK mode

The receiver is equipped with a clock and 4 kinds of timer functions. These functions may be used with broadcasting station programs or utility station schedules.

• Timer types

TIMER TYPE	FUNCTION
POWER ON TIMER	Turns power ON at the pre-set time.
POWER OFF TIMER	Turns power OFF at the pre-set time.
MEMORY SELECT TIMER	Changes the memory channel to the pre-selected one at the pre-set time.
SLEEP TIMER	Turns power OFF after the pre-set time (30, 60 or 90 min.) is passed.

• Flow chart description

CLOCK DISPLAY	Push [CLK] to select the clock display or frequency display.
SLEEP TIMER	Push [FUNC] then [UP] to start or cancel the sleep timer. See p. 22 for the operation and p. 24 for the time setting.
CLOCK MODE	Push [FUNC] then [CLK] to enter CLOCK mode. [UP] selects each timer. (pgs. 23 ~ 24) [DN] selects a timer condition. (p. 21) Digit keys enter the desired time. (p. 22)

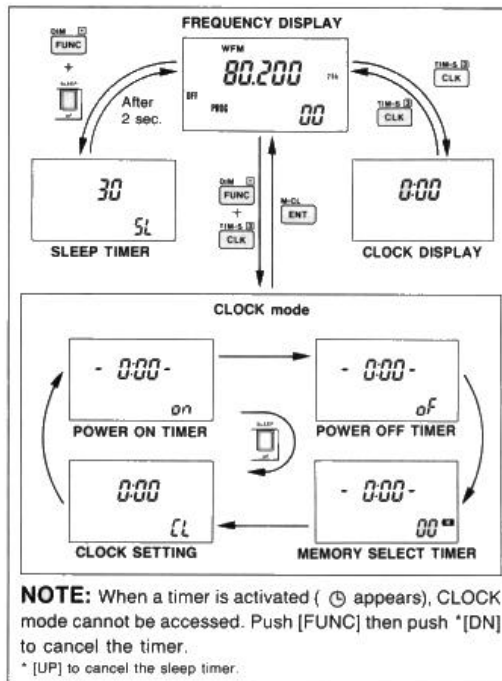

20

7 CLOCK & TIMER

Daily and once-only timer selection

Each timer (power on, power off or memory select timer) has 3 types of timer conditions. Those are timer-off, daily timer and once-only timer.

TIMER OPERATION	FUNCTION
TIMER-OFF	Timer operating time is selected, though the timer does not function.
DAILY TIMER	The selected timer operates everyday.
ONCE-ONLY TIMER	The selected timer operates only one time. After activating the timer, the display automatically changes to the timer-off condition. (Timer operating time is held.)

- Push [FUNC] then [CLK] to access CLOCK mode.
- Push [UP] several times until the desired timer display appears.
- Push [DN] several times until the desired condition (daily timer, once-only timer or timer-off) appears.
 - See pgs. 23 and 24 for setting timer time.
- Push [UP] to select another timer or push [ENT] to return to the frequency display.

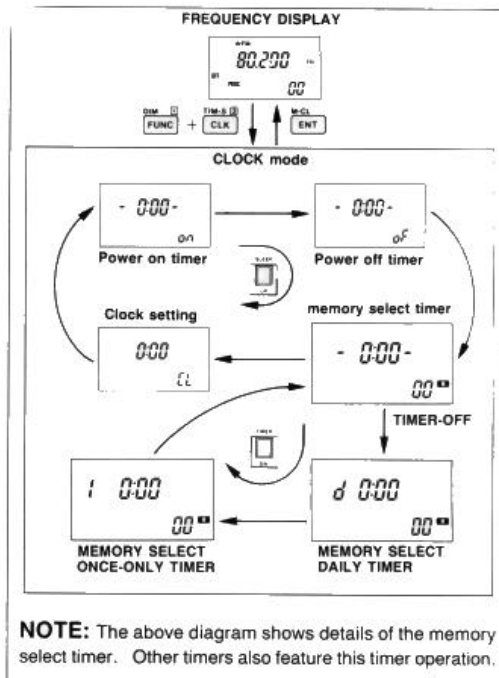

■ Timer start and cancel

• Timer start

- Before starting a timer, be sure of the following points:
 - Clock time is set.
 - Timer operating time is set.
 - The desired timer is selected as the daily or once-only timer.

When starting timers, the function display shows activating timers for approx. 2 sec. as below.

SLEEP TIMER Push [FUNC] then [UP].
OTHER TIMERS Push [FUNC] then [DN].

• Timer starting display

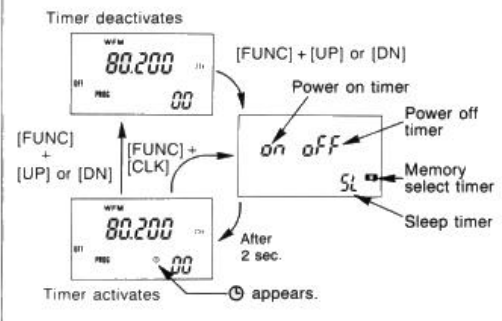

• Timer cancel

- ① When the power is still ON.
SLEEP TIMER Push [FUNC] then [UP].
OTHER TIMERS Push [FUNC] then [DN].
- ② When the power is OFF by the power off or sleep timer.
 Push [PUSH-ON/VOL] twice.
- ③ When waiting that the power on timer functions.
 (Power is now OFF.)
 Push [DN].

■ Time setting

• Before setting

Before setting the time, select the desired timer setting display in CLOCK mode. See p. 20 for details.

• Time entry

Timer operating time and clock time are entered directly with the digit keys. The IC-R100 timer is a 24-hour system so 4 digit input is necessary.

[EXAMPLE]

0:30 → [0][0][3][0] 1:00 → [0][1][0][0]
 5:05 → [0][5][0][5] 11:50 → [1][1][5][0]

7 CLOCK & TIMER

• Time setting examples

CLOCK SETTING

Set the clock to 9:00.

- 1) Be sure the timer function is turned OFF.
 - "Ⓞ" must disappear.
- 2) Access CLOCK mode.
 - Push [FUNC] then [CLK].
- 3) Select the clock setting display.
 - Push [UP] several times until "CL" appears.
- 4) Set the time to 9:00.
 - Push digit keys: [0][9][0][0].
- 5) Return to the frequency display or advance to another timer setting display.
 - Frequency display → Push [ENT].
 - Advance the display → Push [UP].
 - Timer start → Push [FUNC] then [DN].

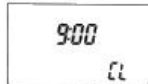
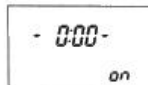

POWER ON TIMER SETTING

Set the power on time to 10:30 as the once-only timer.

- 1) Be sure the timer function is turned OFF.
 - "Ⓞ" must disappear.
- 2) Access CLOCK mode.
 - Push [FUNC] then [CLK].
- 3) Select the power on setting display.
 - Push [UP] several times until "on" appears.
- 4) Select the once-only timer.
 - Push [DN] until "1" appears.
- 5) Set the time to 10:30.
 - Push digit keys: [1][0][3][0].
- 6) Return to the frequency display or advance to another timer setting display.
 - Frequency display → Push [ENT].
 - Advance the display → Push [UP].
 - Timer start → Push [FUNC] then [DN].

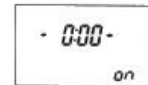

POWER OFF TIMER SETTING

Set the power off time to 21:30 as the daily timer.

- 1) Be sure the timer function is turned OFF.

- "⊙" must disappear.



- 2) Access CLOCK mode.

- Push [FUNC] then [CLK].



- 3) Select the power off setting display.

- Push [UP] several times until "oF" appears.

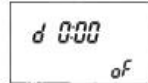

- 4) Select the daily timer.

- Push [DN] until "d" appears.

- 5) Set the time to 21:30.

- Push digit keys: [2][1][3][0].



- 6) Return to the frequency display or advance to another timer setting display.

- Frequency display → Push [ENT].
- Advance the display → Push [UP].
- Timer start → Push [FUNC] then [DN].

**SLEEP TIMER**

Select the sleep time as 90 min.

- 1) Be sure the sleep timer is turned OFF.

- "⊙" must disappear.



- 2) Select the sleep time as 90 min.

- Push [FUNC].
- While pushing [UP] rotate the tuning control.



- 3) Release [UP].

- The sleep timer automatically starts.

**MEMORY SELECT TIMER**

Set that the memory channel 73 will be selected to 17:30 as the daily timer.

- 1) Be sure a timer function is turned OFF.

- 2) Access CLOCK mode.

- 3) Select the memory select timer.

- 4) Select the daily timer.

- 5) Rotate the tuning control to select memory channel 30.

- 6) Set the time to 17:30.

- 7) Return to the frequency display or advance to another timer setting display.

8 MAINTENANCE

■ Troubleshooting

PROBLEM	POSSIBLE CAUSE	SOLUTION	REF.
Power does not come on.	• DC power cable is not connected.	• Connect the cable to the [DC 13.8 V] jack.	p. 5
	• The fuses are blown.	• Check the cause, then replace the fuse.	p. 26
	• Polarity of the power cable connection is reversed.	• Connect the cable properly. white → positive, black → negative	p. 5
Clock indication and the timer indicator appears when power is ON.	• The power on timer is activated.	• Push [DN].	p. 22
The display backlight lights up even when the power is OFF.	• [CLOCK] on the rear panel is set at "LAMP."	• Set the switch to the "OFF" or "ON" position.	p. 4
No sound comes from the speaker.	• The squelch is closed.	• Rotate [SQUELCH] counterclockwise.	p. 11
	• No audio signal is received.	• Change the frequency.	-
	• An external speaker or earphone is connected.	• Check the external speaker or earphone plug connection.	-
Sensitivity is low.	• Wrong antennas are connected.	• Check the connection and properly connect the antennas and antenna connectors again.	p. 7
	• Attenuator is activated.	• Push [PRE/ATT] to turn OFF the attenuator.	p. 11
Scan does not continue.	• Scan resume condition is set at "∞."	• Push [STP-M] to select "OFF" or "PAUSE."	p. 17
	• Squelch is open.	• Rotate [SQUELCH] to close the squelch.	p. 18
The function display occasionally displays erroneous information.	• The internal CPU has malfunctioned.	• Reset the CPU.	p. 26

■ CPU resetting

If the function display occasionally displays erroneous information, the CPU should be reset before sending the receiver to an Icom Dealer or Service Center.

BE CAREFUL! After resetting the CPU, all information you have programmed into the memory channels and clock time is erased.

- 1) Turn power OFF.
- 2) While pushing [FUNC] and [ENT], turn power ON.
 - The function display shows all segments for 2~3 sec. and the display becomes normal.

■ Fuse replacement

If the fuse blows or the receiver stops functioning, find the source of the problem if possible, and replace the damaged fuse with a new, rated fuse. See diagrams at right for replacing the fuse.

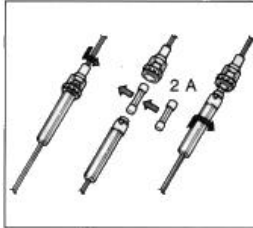

■ Backup batteries

The IC-R100 has a CPU backup battery and clock battery. The usual life is:

- CPU backup battery : approx. 5 years
 Clock battery : approx. 1.5 years.

• CPU backup battery

When the backup battery is exhausted, the receiver operates normally but cannot retain memory information.

CAUTION: CPU backup battery replacement should be done by an authorized Icom Dealer or Service Center.

• Clock battery

When the battery voltage becomes low, the clock is slow or shows malfunctioning numbers.

A CR2032 lithium battery is located under the bottom cover near the rear panel.

After replacing the clock battery, CPU resetting must be performed.

9 SPECIFICATIONS

• Frequency coverage :

U.S.A., Europe, Australia versions	0.1 ~ 1856 MHz*
Germany version	13.95 ~ 14.5 MHz, 28.0 ~ 29.7 MHz, 144.0 ~ 146.0 MHz, 430.0 ~ 440.0 MHz, 1240.0 ~ 1300.0 MHz
France version	0.1 ~ 87.5 MHz, 108.0 ~ 1856 MHz*

*Specifications guaranteed 0.5 ~ 1800 MHz.

- Mode : AM, FM, Wide FM (WFM)
- Tuning step increment : 1, 5, 8, 9, 10, 12.5, 20, 25 kHz
- Antenna impedance : 50 Ω (unbalanced)
- Power supply requirement : 13.8 V DC ± 15% (negative ground)
- Current drain : Less than 1.1 A (at 13.8 V DC)
- Usable temperature range : -10°C ~ +60°C (+14°F ~ +140°F)
- Frequency stability : ±3.5 ppm (at 1800 MHz) (0°C ~ +50°C; +32°F ~ +122°F)
- Dimensions : 150(W) x 50(H) x 181(D) mm
5.9(W) x 2.0(H) x 7.1(D) in (Projections not included)
- Weight : 1.4 kg (3.1 lb)

• Sensitivity :

Frequency	Sensitivity		
	FM	Wide FM	AM
0.5 ~ 1.6295 MHz	—	—	3.2 μV
1.63 ~ 49.9995 MHz	0.56 μV	—	1.6 μV
50.0 ~ 904.9995 MHz	0.2 μV	0.63 μV	0.56 μV
905.0 ~ 1380.4875 MHz	0.32 μV	0.79 μV	1.0 μV
1380.5 ~ 1800.0 MHz	0.45 μV	1.1 μV	1.4 μV

Measurement conditions:

Preamp is ON in the 50 ~ 904.9995 MHz frequency range.

FM 12 dB SINAD (1 kHz modulation with ±3.5 kHz deviation)

WFM 12 dB SINAD (1 kHz modulation with ±50 kHz deviation)

AM 10 dB S/N (1 kHz modulation with 30% depth)

- Selectivity : FM More than 15 kHz/ -6 dB
WFM More than 180 kHz/ -3 dB
AM More than 6 kHz/ -6 dB
- Audio output power : More than 2.5 W at 10% distortion with an 8 Ω load.
- Audio output impedance : 4 ~ 8 Ω

All stated specifications are subject to change without notice or obligation.



**AH-7000 SUPER WIDEBAND
OMNIDIRECTIONAL ANTENNA**

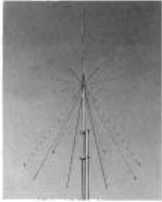

Provides super wideband coverage from 25 to 1300 MHz.

**CP-11 CIGARETTE LIGHTER
CABLE WITH NOISE FILTER**



Easy power connection with a 12 V DC in-car cigarette lighter socket.

AD-15A/E/D/V AC ADAPTER



Large current capacity AC adapter for easy power connection through an AC outlet.

SP-10 EXTERNAL SPEAKER



Compact speaker for mobile operation.

SP-12 EXTERNAL SPEAKER



Slim-type speaker for easy mobile installation. The speaker has a clip to attach to a sun visor, door pocket, etc.

SP-7 EXTERNAL SPEAKER



Stand-type speaker for indoor use. Delivers high-quality sound.

Count on us!

