

KENWOOD

HF TRANSCEIVER

Model TS-430S



INSTRUCTION MANUAL

INTRODUCTION

You are now the owner of our most recent product, the TS-430S amateur band transceiver and general coverage receiver. Please read this instruction manual carefully before placing your new transceiver in service. This equipment has been carefully engineered and manufactured to rigid quality standards, and should give you satisfactory and dependable operation for many years.

AFTER UNPACKING:

- Shipping container:
Save the boxes and packing in the event your unit needs to be transported for remote operation, maintenance, or service.
- The following explicit definitions apply in this manual:

Note: If disregarded, inconvenience only.

No risk of equipment damage or personal injury.

Caution: Equipment damage may occur, but not personal injury.

Accessories

Warranty card*	1
Instruction Manual (B50-4006-00).....	1
Fuse (20A) (F05-2034-05).....	1
Calibration cable (E31-2154-05).....	1
DC power cable (E30-1638-05).....	1
7 pin DIN plug (E07-0751-05).....	1
8 pin DIN plug (E07-0851-05).....	1

* Included only for U.S.A.

CONTENTS

SECTION 1. SPECIFICATIONS	3
SECTION 2. FEATURES	4
SECTION 3. PREPARATION FOR USE	4
SECTION 4. CONTROLS, INDICATORS AND CONNECTORS	
4.1 FRONT AND TOP PANELS	6
4.2 REAR PANEL	8
SECTION 5. OPERATION	
5.1 RECEPTION	9
5.2 TRANSMISSION	11
5.3 VOX OPERATION	13
5.4 SEMI-BREAK-IN OPERATION	13
5.5 OPERATION WITH A LINEAR AMPLIFIER.....	13
5.6 CW OPERATION	13
5.7 KEY BOARD FUNCTIONS.....	14
5.8 MOBILE OPERATION.....	17
5.9 FIXED STATION OPERATION.....	19
SECTION 6. ADDITIONAL INFORMATION	20
SECTION 7. TROUBLE SHOOTING.....	24
SECTION 8. OPTIONAL ACCESSORIES	25
SECTION 9. INTERNAL VIEWS	27
SECTION 10. RADIO FREQUENCY ALLOCATION.....	29
SECTION 11. BLOCK DIAGRAM.....	29
SECTION 12. SCHEMATIC DIAGRAMS.....	30 ~ 34

NOTE:

Before connecting or disconnecting the AC power plug, always be sure to set the POWER switches of the TS-430S and the PS-430 to OFF.

SECTION 1. SPECIFICATIONS

[GENERAL]

Transmitter Frequency Range: 160, 80, 40, 30, 20, 17, 15, 12, 10 meter Amateur bands
Receiver Frequency Range: 150 kHz to 30 MHz
Mode: A3J (LSB, USB), A1 (CW), A3 (AM), F3 (FM)
Antenna Impedance: A3J (LSB, USB), A1 (CW), A3 (AM), F3 (FM)..... OPTION)
Power Requirement: 12.0 to 16.0 V DC (13.8 V nominal)
Power Consumption: 20A approx. in transmit mode
 1.2A approx. in receive mode
Dimensions: 270 (10.6)W x 96 (3.8)H x 257 (10.1) D mm (inch)
Weight: 6.5 kg (14.3 lbs.)

[TRANSMITTER]

Final Power Input:

Band \ Mode	SSB	CW	FM	AM
160m – 15m band	250WPEP	200WDC	–	60W
10m band	250WPEP	200WDC	120W	60W

Modulation:

SSB = Balanced Modulation
 FM = Variable Reactance Direct Shift
 (with FM-430 optional accessory)
 AM = Low Level Modulation (IF stage)

Carrier Suppression:

Better than 40 dB

Unwanted Sideband Suppression:

Better than 50 dB

Harmonic Content:

Less than -40 dB

Maximum Frequency Deviation (FM):

± 5 kHz (with FM-430 optional accessory)

Microphone Impedance:

500Ω to 50 kΩ

[RECEIVER]

Circuitry:

SSB, CW, AM = Double conversion Superheterodyne

FM = Triple Conversion Superheterodyne

Intermediate Frequency:

1st IF = 48.055 MHz

2nd IF = 8.83 MHz

3rd IF = 455 kHz (FM only)

Sensitivity:

Mode \ Frequency	150kHz – 500kHz	500kHz – 1.8MHz	1.8MHz – 30MHz
SSB/CW(10 dB S/N)	Less than 1 μV	Less than 4 μV	Less than 0.25 μV
AM(10 dB S/N)	Less than 13 μV	Less than 40 μV	Less than 2.5 μV
FM (30 dB S/N)	–	–	*Less than 1 μV
FM (12 dB SINAD)	–	–	*Less than 0.7 μV

* with FM-430 optional accessory

Image Ratio:

More than 70 dB (1.8 to 30 MHz)

More than 50 dB (FM-3rd image ratio)

IF Rejection:

More than 70 dB (1.8 to 30 MHz)

Selectivity:

Mode \ Selectivity	-6 dB	-60 dB
SSB/CW	2.4 kHz	4.4 kHz
AM *1	6 kHz	12 kHz
FM *2	15 kHz	32 kHz

* 1 with YK-88A optional filter

* 2 with FM-430 optional accessory

Frequency Stability:

Better than ± 30 × 10⁻⁶ (0°C to +50°C), Within ± 200 Hz from 1 to 60 minutes after turn-on: within ± 30 Hz any 30 minute period thereafter

Frequency Accuracy:

Better than 10 × 10⁻⁶

RIT Variable Range:

More than ± 1 kHz

Audio Output Impedance:

4Ω to 16Ω

Audio Output Power:

More than 1.5W across 8Ω (at 10% distortion)

Note: Circuit and ratings subject to change without notice due to developments in technology.

SECTION 2. FEATURES

150 kHz – 30 MHz GENERAL COVERAGE RECEIVER

ALL MODE OPERATION

Operating mode include USB, LSB, CW, and AM, both transmit and receive, with FM optionally available using the FM-430 frequency modulation unit (installs easily inside the transceiver). Mode selection is made by front panel mode keys with adjacent LED indicators.

SUPERIOR RECEIVER DYNAMIC RANGE

The receiver front-end has been carefully designed to provide an exceptionally wide dynamic range, through the use of 2SK125 junction-type FET's in the RF amplifier and balanced mixer circuits.

DUAL DIGITAL VFO's

- 10 Hz step dual digital VFO's include band and mode information, allowing split frequency or cross-band operation.
- A STEP switch is provided to permit tuning in 10 Hz (10 kHz/revolution of the tuning knob), or 100 Hz (100 kHz/revolution) steps.
- An A = B switch is provided to bring the idle VFO to the active VFO mode and frequency.
- A VFO LOCK switch is provided.
- The RIT control allows shifting the receive frequency in either VFO or memory mode operation.

EIGHT MEMORY CHANNELS

- Each memory stores frequency, mode and band information.
- The memory CH 8 stores both a receive and a transmit frequency for split-frequency memory operation.
- A front panel MR switch is provided to allow the operator to operate each of the eight memories as an independent VFO, or as a fixed frequency.

LITHIUM BATTERY MEMORY BACK-UP

All memory and VFO information are backed-up by an internal lithium battery (estimated 5 year life).

MEMORY SCAN

Scans only those memory channels in which data is stored. The scanning time is approximately 1.8 sec. for each channel, with a HOLD switch provided to interrupt the scan.

PROGRAMMABLE BAND SCAN

Scans within the programmed band width. Memory channel 6 establishes the lower band scan limit, memory channel 7 the upper limit. The HOLD switch interrupts the scan. Scan speed is externally adjustable.

AUTOMATIC ANTENNA TUNER CONTROL

The band selection of the automatic antenna tuner AT-250 and TS-430 is possible.

IF SHIFT CIRCUIT

The apparent IF passband may be shifted to place interfering signals outside the passband, while keeping the desired signal optimally placed for best signal-to-noise ratio.

TUNABLE NOTCH FILTER

SPEECH PROCESSOR

The speech processor uses an audio compression amplifier and change in the ALC time constant, resulting in substantially increased "talk-power".

ALL SOLID-STATE

The TS-430S runs 250W PEP input on CW, on 160-10 meters. In the AM mode, it runs 60W input, all bands. In the FM mode (optional FM-430 unit installed), it runs 120W input. A built-in cooling fan, plus other protection circuitry assures maximum final amplifier reliability. Both the receiver and the solid-state wide band final amplifier requires no tuning.

NOISE BLANKER

An effective noise-blanker eliminates pulse-type interference such as ignition noise.

RF ATTENUATOR

The carefully designed receiver front-end includes a switchable 20 dB RF attenuator for intermodulation distortion rejection.

VOX CIRCUIT

Both VOX and push-to-talk operation available. VOX gain, delay and anti-VOX controls are located on top of the cabinet, for easy adjustment. Semi-break-in operation available in CW, using the built-in sidetone oscillator.

RUGGED CONSTRUCTION AND STYLING

The TS-430S is styled to enhance the appearance of any fixed or mobile station, while providing maximum ease of operation through a functional layout of the controls.

BUILT-IN SQUELCH CIRCUIT EFFECTIVE FOR ALL MODES

OTHER FEATURES

- Meter reads S in receive, IC or ALC in transmit.
- An audible "beep" from the speaker confirms key entry operations.
- Indicators provided for VFO A/B, ON AIR, F.LOCK, F.STEP, RIT, NOTCH, M.CH, and MODE.
- VFO dial drag externally adjustable.
- Remote terminal provided for linear amplifier control.
- Accessory terminal provides band information.
- Transverter terminal is provided on the rear panel.

SECTION 3. PREPARATION FOR USE

INTERCONNECTION

Connect the transceiver as illustrated in Fig. 3-1, 3-2.

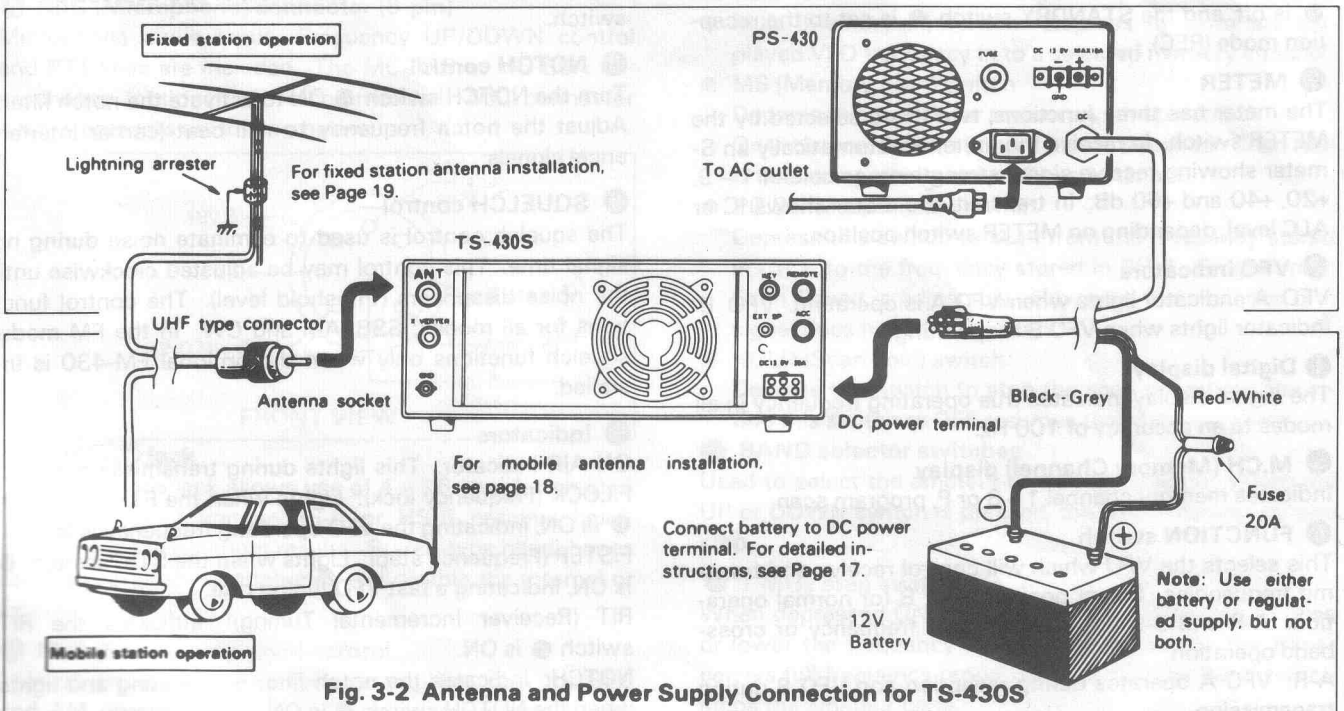
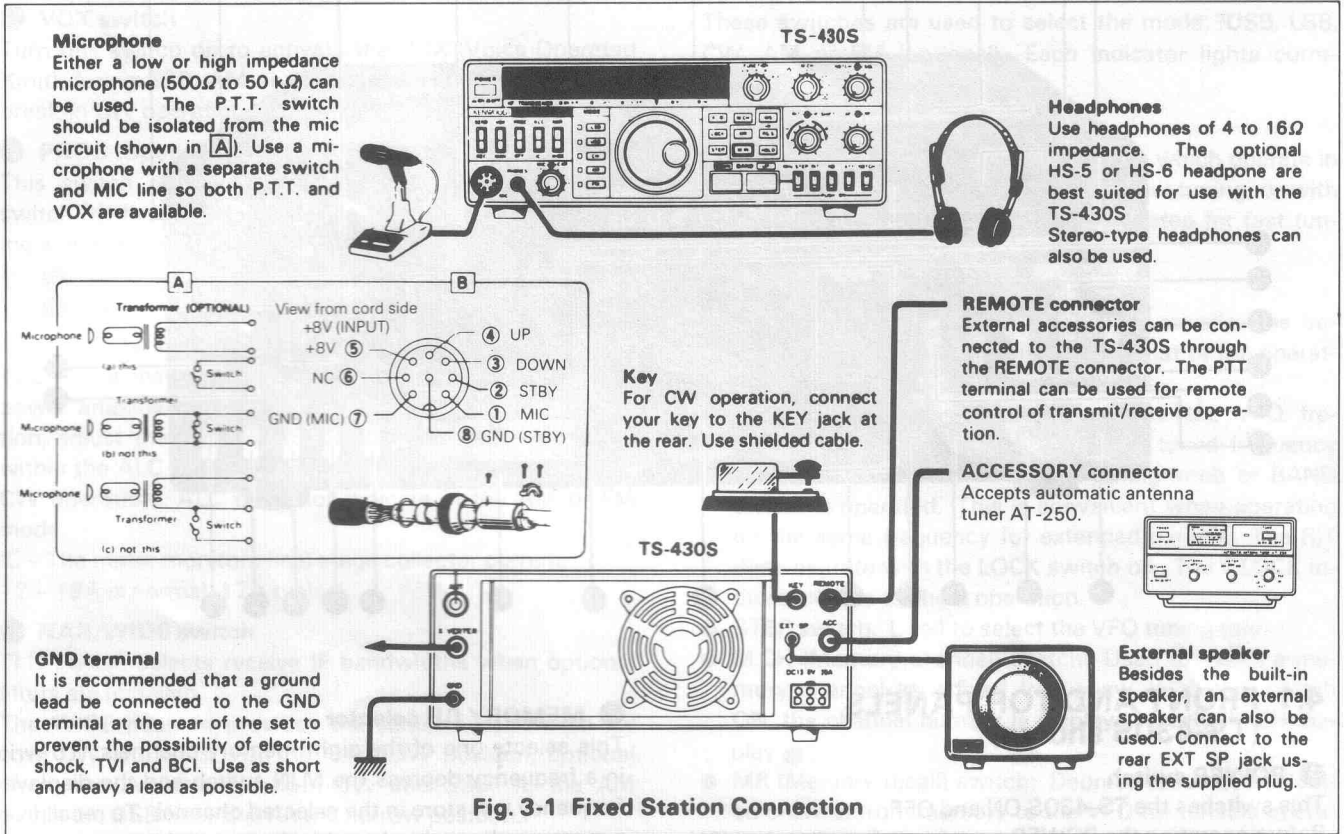

SECTION 4. CONTROLS, INDICATORS AND CONNECTORS

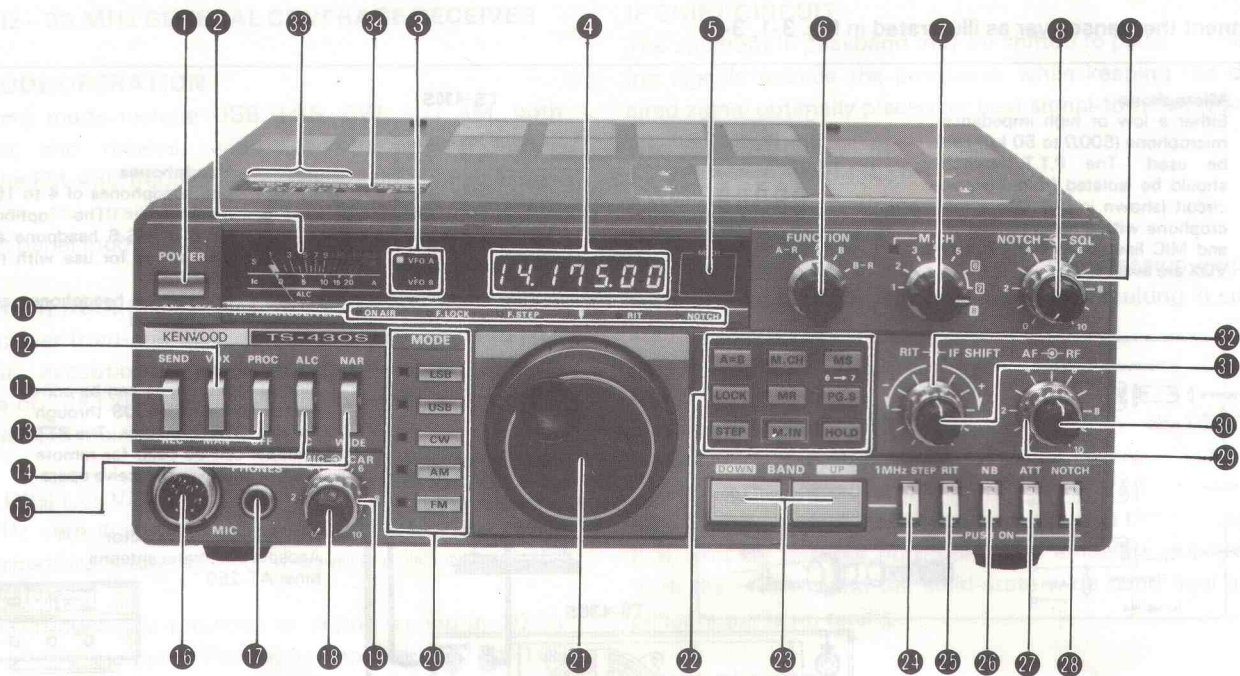

4.1 FRONT AND TOP PANELS (TS-430S shown)

① POWER switch

This switches the TS-430S ON and OFF. Before operating the POWER switch, confirm that the VOX ⑫ is off, and the STANDBY switch ⑪ is set to the reception mode (REC).

② METER

The meter has three functions, two being selected by the METER switch. In receive the meter is automatically an S-meter showing receive signal strength on a scale of 1 – 9, +20, +40 and +60 dB. In transmit, the meter shows IC or ALC level, depending on METER switch position.

③ VFO indicators

VFO A indicator lights when VFO A is operating. VFO B indicator lights when VFO B is operating.

④ Digital display

The digital display indicates true operating frequency in all modes to an accuracy of 100 Hz.

⑤ M.CH (Memory Channel) display

Indicates memory channel 1 – 8 or P, program scan.

⑥ FUNCTION switch

This selects the VFO which will control receive and transmit frequencies. Select position A or B for normal operation. A-R and B-R are used for split frequency or cross-band operation.

A-R: VFO A operates during reception and VFO B during transmission.

A: VFO A operated, VFO B stands by.

B: VFO B operates, VFO A stands by.

B-R: VFO B operates during reception and VFO A during transmission.

⑦ MEMORY CH selector

This selects one of the eight memory channels. To write in a frequency depress the M.IN switch and the displayed frequency will store in the selected channel. To recall from a memory channel, select the channel and depress the MR switch.

⑧ NOTCH control

Turn the NOTCH switch ⑳ ON to activate the notch filter. Adjust the notch frequency to null beat (carrier interference) signals.

⑨ SQUELCH control

The squelch control is used to eliminate noise during no signal time. This control may be adjusted clockwise until the noise disappears (threshold level). The control functions for all modes; SSB, AM and CW. In the FM mode, squelch functions only when the optional FM-430 is installed.

⑩ Indicators

ON AIR indicator: This lights during transmission mode.

F.LOCK (Frequency lock): Lights when the F.LOCK switch ㉒ is ON, indicating the VFO operating frequency is locked.

F.STEP (Frequency step): Lights when the STEP switch ㉑ is ON, indicating a fast VFO tuning rate.

RIT (Receiver Incremental Tuning): Indicates the RIT switch ㉓ is ON.

NOTCH: Indicates the notch filter is operating and lights when the NOTCH switch ㉔ is ON.

⑪ STANDBY switch

This switch selects:

REC: The transceiver is receiving unless the microphone PTT switch or the VOX circuit is activated.

SEND: Locks the unit in transmit. Transmission is locked out (reception only) if the selected transmission frequency is outside the amateur radio bands, or the final stage thermal-protects (is deactivated due to excessive heat-sink temperature).

12 VOX switch

Turn this switch on to activate the VOX (Voice Operated Xmit) during SSB, AM or FM operation or to allow semi-break-in CW operation.

13 PROC (Speech processor) switch

This switch is used during SSB or AM operation. At switch ON the speech processor will be activated, increasing average "talk power".

14 METER switch

During transmission, the meter switch determines meter function. The switch selects between:

ALC – The meter monitors the output of the final stage power amplifier during transmission. During SSB operation, adjust the MIC control so that the meter pointer is within the ALC zone. Similarly, adjust the CAR control for CW operation. ALC does not indicate in the AM or FM mode.

IC – The meter monitors final stage collector current. 12 – 19A is normal, 17A typical.

15 NAR/WIDE switch

This switch selects receive IF bandwidths when optional filters are installed.

The WIDE position provides the same IF bandwidth for both CW and SSB. For the NARROW position, optional filters are available for both CW and SSB. In the AM mode, the SSB filter is on in the narrow position.

16 MIC (Microphone) connector (8-pin)

Microphone audio input. Frequency UP/DOWN control and PTT lines are included. The MC-42S or MC-60A microphones (optional) are recommended. MIC connector pin assignments are shown below.

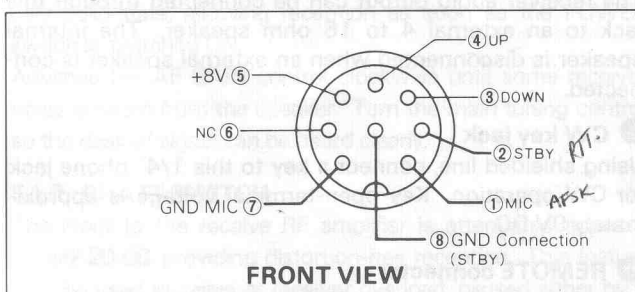

17 PHONES jack

The headphone jack allows use of 4 – 16 ohm (or greater) impedance headphones. HS-5 or HS-6 optional headphones provide optimum results. Stereo-type headphones can also be used. Headphones will disable the internal or external speaker.

18 MIC (Microphone gain) control

This control adjusts microphone amplifier gain for SSB and AM operation. In the SSB mode, adjust for an on-scale ALC reading at voice peaks. For low power operation, adjust this control below the ALC range. For AM mode adjustment, see "AM transmission" page 11.

19 CAR (CARRIER LEVEL) CONTROL

This controls carrier level during CW operation. Adjust the carrier level for an on-scale ALC meter reading. For low-power operation, adjust this control below the ALC range.

20 MODE switches and indicators

These switches are used to select the mode; USB, LSB, CW, AM or FM (optional). Each indicator lights corresponding to the mode.

21 Tuning Knob

This knob controls the dual digital VFO's which operate in 10 Hz step at 10 kHz turn for normal slow tuning, or with the STEP switch depressed, at 100 Hz step for fast tuning.

22 Keyboard

A = B switch: Depress this switch to equalize the frequency and mode of the idle VFO to that of the operating VFO.

LOCK switch: This electrically locks the VFO frequency. When this switch is on, the tuned frequency does not vary when either the tuning knob or BAND switch is operated. This is convenient when operating on the same frequency for extended periods. The RIT does operate with the LOCK switch on. The F.LOCK indicator lights to show operation.

STEP switch: Used to select the VFO tuning rate.

M.CH (Memory channel) switch: Used to select a memory channel as a fixed frequency. With this switch ON, the channel number is displayed on the M.CH display 5.

MR (Memory recall) switch: Depress to recall a selected channel from memory to the VFO for tunable operation.

M.IN (Memory in) switch: Depress to store the displayed VFO frequency in to a selected memory channel.

MS (Memory scan) switch

Depress this switch for memory scan operation.

Only channels with stored data are scanned. Scan rate is fixed at approximately 1.8 sec./channel.

PG.S (Program scan) switch

Depress this switch to scan from the frequency stored in CH 6 to the frequency stored in CH 7. Programmed Scan Speed is adjustable. However, the presence of a signal does not stop the scan.

HOLD (Scan hold) switch

Depress this switch to stop the scan operation. Resetting this switch to OFF resumes the scan operation.

23 BAND selector switches

Used to select the amateur or frequency band. When the UP or DOWN switch is pressed, the band changes by one step.

24 1 MHz step switch

When depressed ON, this allows the band switch to raise or lower the frequency in 1 MHz steps within the transceivers full frequency range. At OFF (out) the Band switch steps the amateur band.

25 RIT switch

This push switch turns the RIT (Receiver Incremental Tuning) circuit ON and OFF. With the switch depressed, the circuit is activated and the RIT indicator is illuminated, allowing the receive frequency to be shifted by about 1 kHz independent of the transmit frequency by using the RIT control. The RIT circuit is turned OFF when the switch is out.

26 NB (Noise Blanker) switch

This switch is used to reduce pulsating type ignition noises usually emitted from motor vehicles. Power-line, QRM and atmospheric "white" noise will not operate the noise blanker.

27 RF ATT (Attenuator) switch

With this switch ON, a 20 dB attenuator is inserted in the antenna circuit, protecting the RF amplifier and mixer from overload on strong input signals.

28 NOTCH switch

This switch controls the NOTCH circuit and indicator.

29 RF GAIN control

This adjusts receiver RF amplifier gain. Turn fully clockwise for maximum gain and a correct S-meter reading.

30 AF GAIN (Audio Frequency) control

This control adjusts the receiver audio output level. Volume increases as the control is turned clockwise.

31 RIT control

When the RIT switch is ON, this will vary the receive frequency by about 1 kHz. When the control is set to the "0" center position, there is no frequency shift.

32 IF SHIFT control

By using this control, the IF crystal filter center frequency can be shifted about 1 kHz, allowing adjustment of tone quality, or eliminating interference from adjacent frequencies. For normal operation, this control should be set to the center "0" position (at the detent).

33 VOX controls

VOX GAIN: This controls sensitivity of the VOX (Voice operated Transmit) circuit. Adjust the gain for consistent key-over by voice, but not back ground noise.

DELAY control: This controls hold time for VOX, or CW semi-break-in operation. Adjust to hold the transmitter on between words, at a normal speech, or keying rate.

ANTI-VOX control

This control is used to adjust the VOX system so that it is not false tripped by sound from the speaker.

34 PG.SCAN (Program scan) control

This adjusts program scan speed.

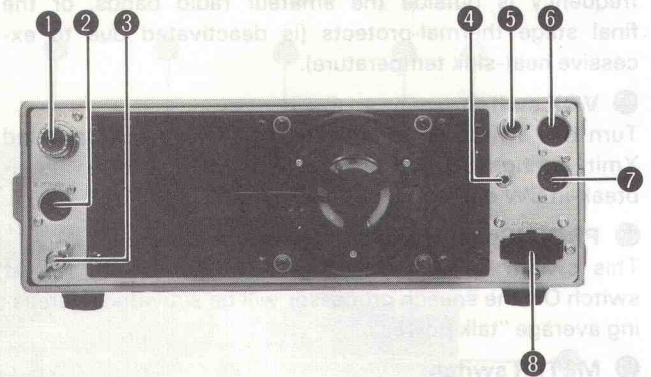

4.2 REAR PANEL

1 ANT (Antenna) connector

This UHF connector should be attached to a suitable antenna for transmitting and receiving. The antenna cable should be 50-ohm coax, terminated with a PL-259 connector.

2 X. VERTER (transverter) terminal

This 8 Pin DIN connector is used to interface a VHF or UHF transverter.

See page 23 for pin-outs.

3 GND (Ground) terminal

To prevent electric shock, as well as RFI and BCI, connect the transceiver to a good earth ground.

4 EXT. SP (External speaker) jack

The receiver audio output can be connected through this jack to an external 4 to 16 ohm speaker. The internal speaker is disconnected when an external speaker is connected.

5 CW key jack

Using shielded line, connect a key to this 1/4" phone jack for CW operation. Key open-terminal voltage is approximately 9V DC.

6 REMOTE connector

This connector is used to interconnect a linear amplifier or other accessory item.

7 ACC (Accessory) connector

This connector is used to access the automatic antenna tuner AT-250. Refer to page 22.

8 DC POWER connector

This is used to connect the DC power supply.

SECTION 5. OPERATION

Note: ① denotes transmit mode; ② denotes receive mode.

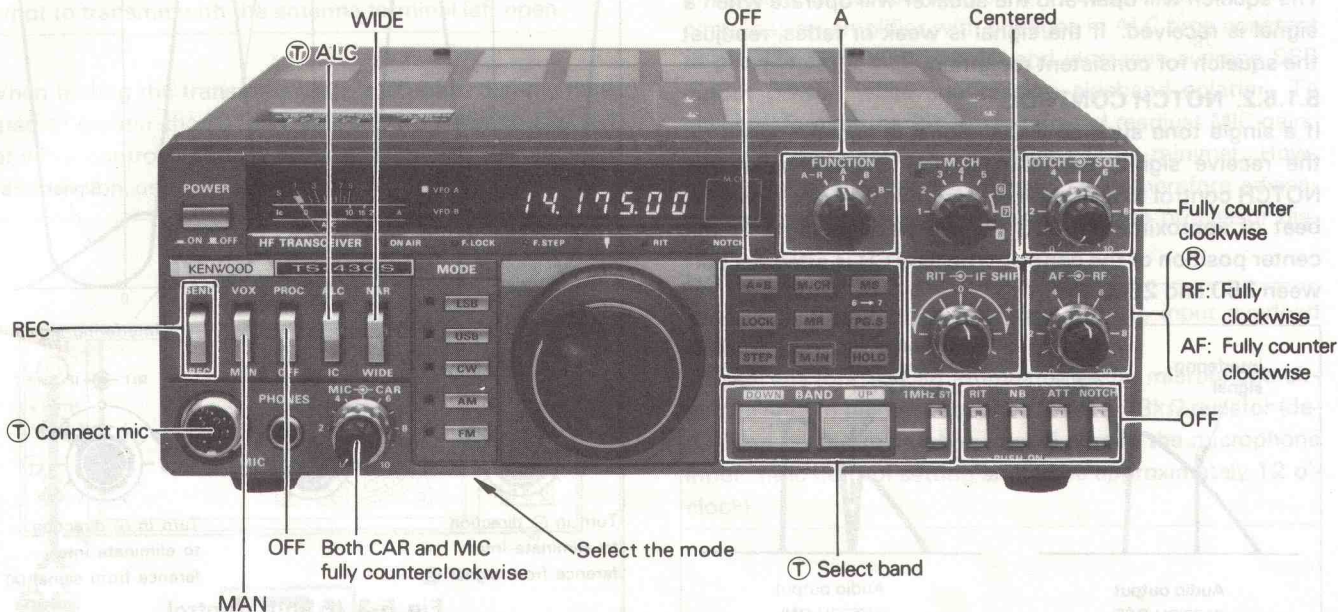

Fig. 5-1 Initial Control Settings

5.1 RECEPTION

5.1.1. RECEPTION

First connect the antenna, microphone and key. Then, set the controls and switches referring to Fig. 5-1.

Ascertain that the TS-430S is ready for operation, then turn the POWER switch ON. The meter and digital display will illuminate, indicating the transceiver is in operation. The transceiver is fully solid-state, allowing reception as soon as the POWER switch is switched ON.

Advance the AF GAIN control clockwise until some receiver noise is heard from the speaker. Turn the main tuning control so the desired signal can be heard clearly.

5.1.2. RF ATT SWITCH

The input to the receive RF amplifier is attenuated approximately 20 dB, providing distortion-free reception. This feature may be used in cases of receiver overload, caused either by a strong local signal, or during weak signal reception when a strong adjacent signal may blank the receiver.

5.1.3. NB SWITCH

The TS-430S has a sophisticated noise blanker designed to reduce ignition-type pulse noise. The noise blanker is particularly important for mobile operation. When necessary, activate the noise-blanker by depressing the NB switch ON.

5.1.4. RF GAIN CONTROL (Fig. 5-2)

For normal operation, this control should be turned fully clockwise for maximum sensitivity. Receive sensitivity is reduced by turning the control counterclockwise.

Adjust the RF GAIN so the S-meter does not show excessive deflection. This minimizes noise during reception and allows the S-meter to indicate signal peak (or a little below that point). Noise is markedly reduced when signal is absent.

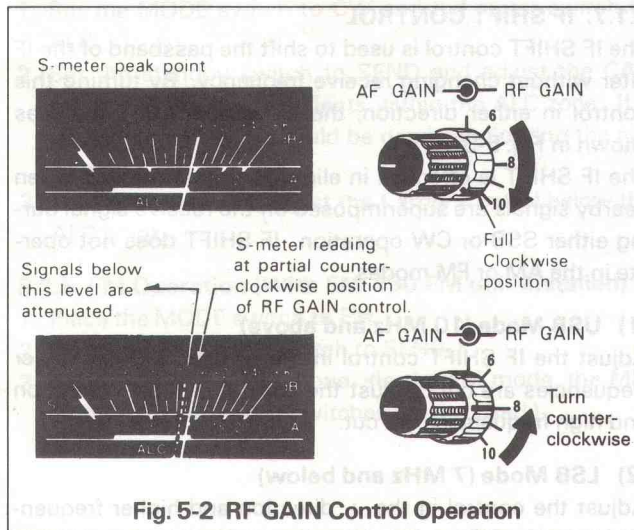

Fig. 5-2 RF GAIN Control Operation

5.1.5.1. SQUELCH

To eliminate receiver noise at the no-signal condition, slowly advance the squelch clockwise until the noise just disappears (threshold point).

The squelch will open and the speaker will operate when a signal is received. If the signal is weak or fades, readjust the squelch for consistent reception.

5.1.5.2. NOTCH CONTROL

If a single tone such as a CW signal is superimposed on the receive signal, turn the NOTCH ON and adjust the NOTCH control to eliminate or minimize the beat signal. A beat of approximately 900 Hz can be eliminated at the center position of the control. The NOTCH is effective between 350 and 2600 Hz.

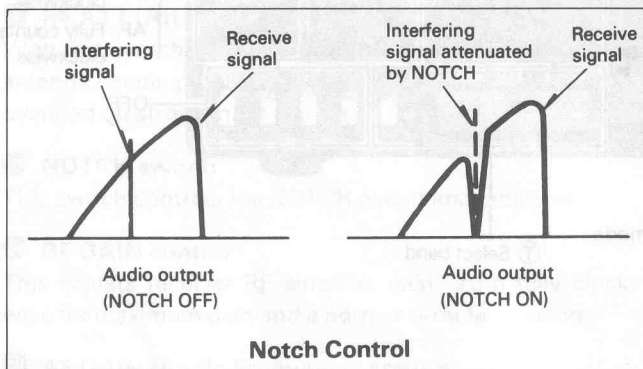

5.1.6. RIT CONTROL

By using the RIT (Receiver Incremental Tuning) control, the receive frequency can be shifted by about ± 1 kHz without changing the transmit frequency.

If the frequency of the station you are working changes, your receive frequency can be reset by turning the RIT switch ON and adjusting the RIT control. Adjusting the control clockwise increases the frequency. When first calling another station, the RIT should be OFF, otherwise your transmit and receive frequency will not coincide.

5.1.7. IF SHIFT CONTROL

The IF SHIFT control is used to shift the passband of the IF filter without changing receive frequency. By turning this control in either direction, the IF passband is shifted as shown in Fig. 5-3.

The IF SHIFT is effective in eliminating interference when nearby signals are superimposed on the receive signal during either SSB or CW operation. IF SHIFT does not operate in the AM or FM modes.

(1) USB Mode (10 MHz and above)

Adjust the IF SHIFT control in the + direction and lower frequencies are cut. Adjust the control in the - direction and high frequencies are cut.

(2) LSB Mode (7 MHz and below)

Adjust the control in the + direction and higher frequencies are cut. Adjust the control in the - direction and low frequencies are cut.

(3) CW Mode

By using the IF SHIFT in conjunction with the RIT, tone quality can be adjusted.

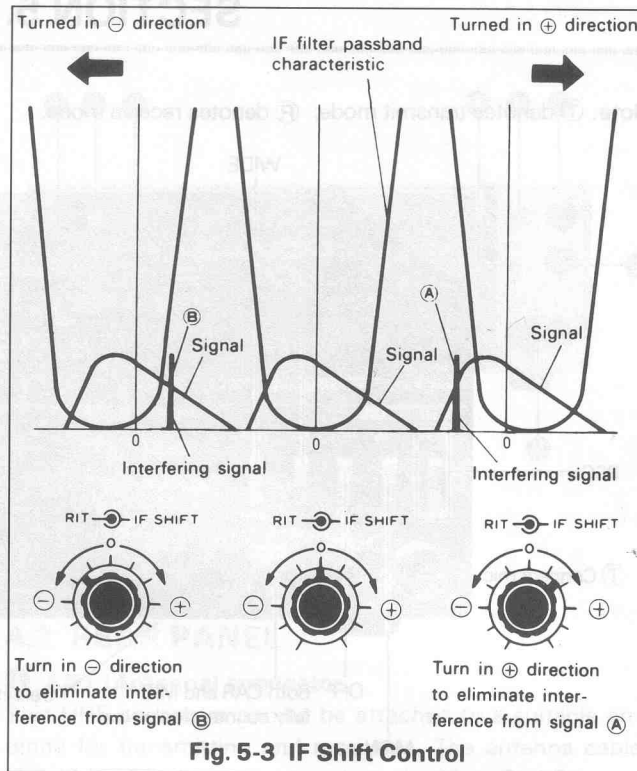

5.1.8. NAR-WIDE switch operation

For short to medium distance communication, the WIDE position may be used for both SSB and CW operation. For DX (long distance) communication, the NAR position will be an advantage in reducing interference.

This feature, in combination with the IF SHIFT control, will provide outstanding interference rejection. The receive IF bandwidth is 2.4 kHz in the SSB and CW wide position, 270 or 500 Hz for CW (with optional filters YK-88CN or YK-88C) and 1.8 kHz for SSB (with optional filter YK-88SN), in the NAR position.

*In the AM MODE without an optional filter, both WIDE NARROW positions are 2.4 kHz. With a YK-88A, Wide is 6 kHz, and Narrow is 2.4 kHz.

*In transmit bandwidth is automatically WIDE.

PASSBAND WIDTH (-6 dB) kHz

MODE / FILTER	CW		SSB		AM
	WIDE	NARROW	WIDE	NARROW	WIDE NAR
No optional filter	2.4	*	2.4	*	2.4
YK-88C or CN	2.4	500 or 270	-	-	-
YK-88SN	-	-	2.4	1.8	-
YK-88A	-	-	-	-	6

NOTE:

- Without optional filters, there is no SSB or CW reception in the NAR switch position (*).
- The NAR/WIDE switch does not function in the AM, FM mode.
- Without an optional filter, the AM mode bandwidth is 2.4 kHz.

5.2 TRANSMISSION (Fig. 5-4)

CAUTION:

Before transmitting, be sure to connect an antenna or dummy load with a VSWR of less than 1.5:1. Never attempt to transmit with the antenna terminal left open.

When testing the transmitter, use a 50-ohm dummy load, rated at greater than 100W (TS-430S). Refer to Fig. 5-1 for initial control settings. When the TS-430S is ready for transmission, use the following procedures:

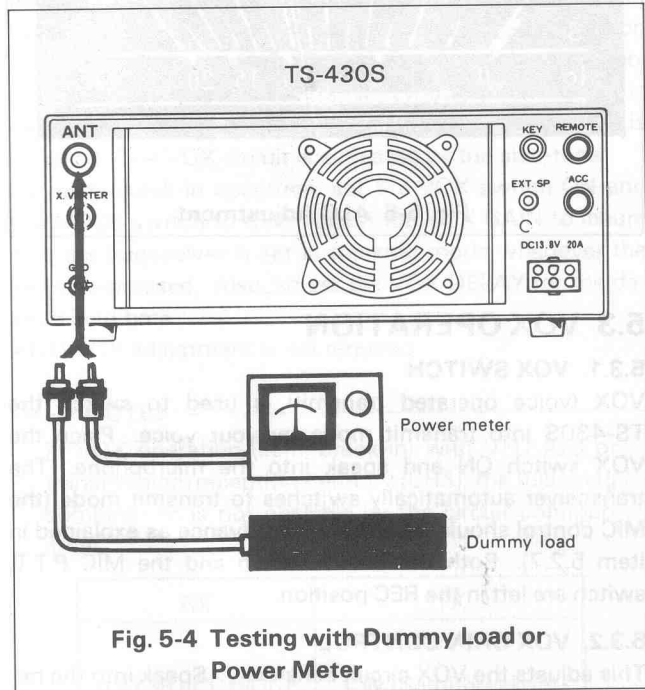

Fig. 5-4 Testing with Dummy Load or Power Meter

5.2.1 SSB Operation

1. Set the MODE switch to SSB.
2. Meter switch to ALC.
3. Standby switch to SEND.
4. Speak into the microphone and adjust the MIC GAIN for meter deflection within the ALC zone at signal peaks.
5. For QRP (Low Power) operation, use less MIC GAIN and consult your external wattmeter for output level.

5.2.2 AM Operation

1. Set the MODE switch to AM and the meter switch to IC.
2. Place the STANDBY switch to SEND and adjust the CAR control so the meter registers approximately 2/3 its usual deflection.
3. Speak into the microphone and advance the MIC GAIN control so the meter deflects only slightly at peaks. Note that excessive meter deflection indicates overmodulation.
4. The PROC may be used to provide a more constant modulation level.

5.2.3 PROC (processor) operation

In DX (long distance) SSB or AM operation, it may be desirable to increase talk-power by using the speech processor.

The speech processor in the TS-430S combines an audio compression amplifier with changes in ALC time constant to provide extra audio punch and increases average SSB output power, while suppressing sideband splatter. To activate, turn on the PROC switch, and readjust MIC gain. Operated as described, distortion will be minimal. However, tone quality will be affected. It is therefore advisable to conduct normal operation with the processor disabled.

NOTE:

When a high-output microphone is used, input overload and distortion may result.

To prevent this, use an attenuator in the microphone circuit as shown below, or connect a 10 – 33k Ω resistor (depending on the microphone used) across the microphone input. (Mic control setting should be approximately 12 o'clock)

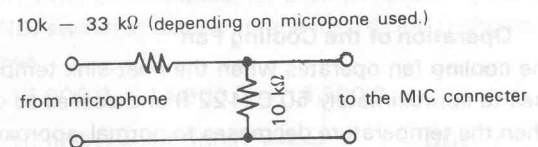

The MC-60A microphone is recommended (Microphone sensitivity: $-55 \pm 3\text{dB}$ for approx. 5 cm distance to the mic). The MC-60A MIC AMP Switch should be set at the OUT position.

5.2.4 CW Operation

1. Set the MODE switch to CW and the meter switch to ALC.
2. Set the standby switch to SEND and adjust the CAR control so the meter deflects within the ALC zone. If a key is connected, it should be depressed during the adjustment.
3. For QRP operation, adjust the Carrier Control below the ALC point.

5.2.5 FM Operation (With FM-430 FM unit installed)

1. Place the MODE switch to FM.
2. Place the STANDBY switch to SEND.
3. Speak into the microphone. (In the FM mode, the MIC GAIN, CAR and meter switches are not used.)

5.2.6. FINAL STAGE PROTECTION

The TS-430S features a VSWR protection circuit to protect the final-amplifier transistors.

Three different protection circuits are used.

1. The final-stage transistors are protected by detecting VSWR of the antenna system and automatically lowering transmitter output power if the VSWR is too high.
2. When the heat-sink temperature rises, a detection circuit activates a cooling fan. Under normal conditions, this cooling fan sufficiently cools the heat sink.
3. The heat-sink temperature could rise abnormally during long transmissions, if the area adjacent to the heat-sink is blocked. In this case, the transmission is inhibited until the heat-sink cools to the proper temperature.

NOTES:

1. If transmitter output decreases due to activation of the protection circuit caused by high VSWR, carefully re-check and retune the antenna system.
2. When the cooling fan starts to operate, determine that adequate air flow is possible in the heat-sink area.

● Operation of the Cooling Fan

The cooling fan operates when the heat-sink temperature rises to approximately 50°C (122°F) and ceases to operate when the temperature decreases to normal, approximately 40°C (104°F). The heat-sink is made of die-cast aluminum and is actually the rear panel. It must be kept clear of surrounding objects to allow heat to dissipate easily.

The cooling fan is designed to operate when the heat-sink temperature is at a specific level, regardless of whether the unit is in transmit or receive mode.

5.2.7. MIC GAIN CONTROL (Fig. 5-5)

This control adjusts the microphone input level. When using the TS-430S in a voice mode, connect a microphone and set the STANDBY switch to SEND (an antenna or dummy load must be connected).

For SSB operation, set the meter switch to ALC and speak into the microphone. Adjust the MIC GAIN control so the meter does not deflect out of the ALC zone at signal peaks.

The TS-430S accepts either a low or high impedance microphone (500 Ω to 50 k Ω). When using a low impedance microphone (500 Ω) the MIC GAIN control should be advanced slightly higher than when a high impedance microphone is used, while observing the ALC meter.

● ALC (Automatic Level Control)

The ALC monitors the transmitter final stage output to minimize distortion in your transmitted signal. It automatically adjusts output to an optimum level.

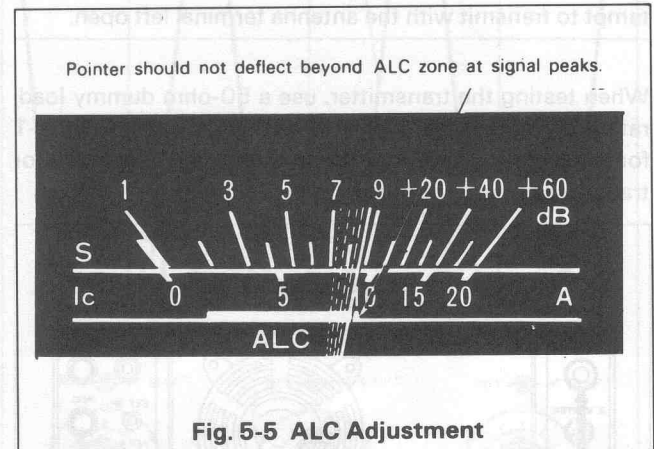

Fig. 5-5 ALC Adjustment

5.3 VOX OPERATION

5.3.1. VOX SWITCH

VOX (voice operated transmit) is used to switch the TS-430S into transmit mode by your voice. Place the VOX switch ON and speak into the microphone. The transceiver automatically switches to transmit mode (the MIC control should be adjusted in advance as explained in Item 5.2.7). Both the SEND switch and the MIC P.T.T. switch are left in the REC position.

5.3.2. VOX GAIN CONTROL

This adjusts the VOX circuit sensitivity. Speak into the microphone at a normal voice level and adjust the control. Increased sensitivity allows transmission with a lower voice level. Transceiver operating condition (receive or transmit) can be checked by the ON AIR LED.

Note that if the control is advanced too far, the VOX circuit may be "tripped" by ambient noise.

5.3.3. ANTI-VOX CONTROL

This prevents the VOX circuit from being false-tripped by sound from the speaker.

Adjust the control so the VOX will not operate at the desired speaker volume level.

5.3.4. VOX DELAY CONTROL

This control adjusts the VOX circuit transmit hold time. If the hold time is too short, the transceiver will return to receive mode as soon as you stop talking into the microphone. This can be eliminated by advancing the control. Adjust the control for comfortable operation at a normal rate of speech.

5.4 SEMI-BREAK-IN OPERATION

The TS-430S has a built-in side-tone oscillator which, used in conjunction with the VOX circuit, allows semi-break-in operation, besides the conventional (SEND switch controlled) CW operation. During semi-break-in operation, the transceiver is placed in transmit mode when the key is depressed, and returns to receive mode when the key is released. The VOX circuit is activated by the side-tone. For semi-break-in operation, set the VOX switch ON and the MODE switch to CW. Adjust the VOX GAIN to insure that the transceiver is set in transmit mode whenever the key is depressed. Also, adjust the VOX DELAY for the desired hold time.

ANTI VOX adjustment is not required.

NOTES:

In VOX operation (semi-break-in) with VFO A/B or transmission/reception memory (CH8), the following combination is not possible by the circuit configuration.

RX	TX
ANY VOICE MODE	CW (Semi-break-in)
CW	LSB, USB (VOX) Any voice mode VOX

5.5 OPERATION WITH A LINEAR AMPLIFIER

The remote connector on the rear panel provides for interconnection with an amplifier. See the amplifier instruction manual to determine whether the linear requires a normally opened or normally closed (during receive) relay contact. Connect the amplifier control line to either pin 5 (N.C.) or pin 4 (N.O. during receive). Connect the Ground (Shield) of the Control Line to Pin 2. Connect amplifier ALC to pin 6 of the remote connector. The TS-430S output is quite adequate to drive most amplifiers to full rated output.

For full details, see section 6.8, page 22.

5.6 CW OPERATION

For CW operation, your transmit frequency should be "zero-beat" to the transmit frequency of the station you are contacting. This also allows your contact to receive your signal without having to retune his receiver. Tuning methods are detailed in the following paragraphs.

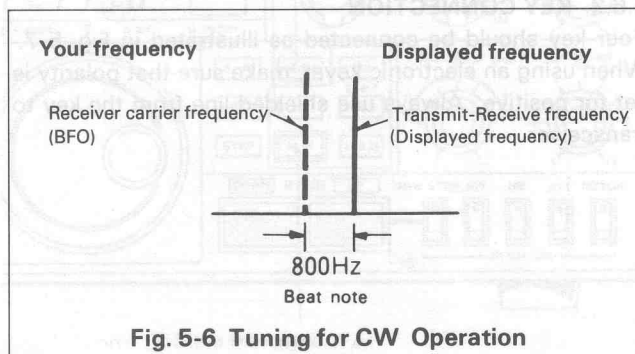

Fig. 5-6 Tuning for CW Operation

NOTE:

- In CW mode, transmit frequency is displayed when both transmitting or receiving.
- During CW operation, operating the BAND switch differs from other modes; for example, pressing the UP (BAND) switch at display frequency 14,000.0 shows as follows.

14,000.0 → 14,500.0 → 18,500.0 → UP
 10,500.0 ← 14,500.0 ← DOWN

5.6.1. OPERATION WITHOUT AN OPTIONAL CW FILTER

Set the IF SHIFT control to its center position and the RIT switch OFF. Adjust the main tuning control for an 800-Hz beat note and your transmit frequency will then coincide with that of your contact station ("zero-beat"). During reception, the side-tone monitor is activated by pressing down the key (VOX OFF). In this case, listen to the side-tone superimposed on the receive signal and adjust the main tuning for similar side-tone and incoming CW audio tone. By so doing, transmit frequencies will coincide. You may now adjust the RIT for a pitch which suits your preference. If interference is encountered, adjust the IF SHIFT. For more convenient and effective CW operation, use of the optional YK-88C or YK-88CN CW crystal filter is recommended.

5.6.2. OPERATION WITH A CW FILTER

Set the IF SHIFT to its center position and the RIT to OFF. Adjust the main tuning control for maximum deflection of the S-meter. Receive signal pitch will be about 800 Hz, indicating correct tuning.

5.6.3. KEY CONNECTION

Your key should be connected as illustrated in Fig. 5-7. When using an electronic keyer, make sure that polarity is set for positive. Always use shielded line from the key to transceiver.

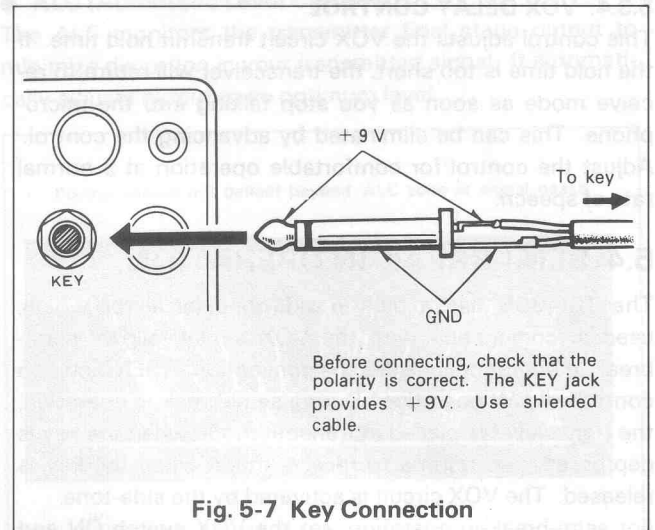

Fig. 5-7 Key Connection

5.7 Keyboard function

Brings the idle VFO frequency and mode to that of the active VFO.

Locks the operating frequency.

Switches to RAPID frequency step for VFO step tuning or program scanning. Step is 10 Hz in the normal position, and 100 Hz in the ON position.

Inputs both frequency and mode into a selected memory channel (CH's 1-8).

Depress to recall a memory channel. Select the channel with the M.CH switch.

Depress to scan the memory channels.

Scans the range between CH 6 frequency and CH 7 frequency.

Holds scan. During program scan hold, frequency can be tuned with the VFO control and the mode can be switched.

When this switch is depressed, the channel selected by the M.CH switch is recalled to the VFO for tunable operation. The mode can also be controlled when recalled by the MR switch.

● Erasing an unwanted frequency from memory

Unwanted memory content can be erased.

1. Depress the M.CH switch, and select the channel to be erased with the M.CH switch.
2. Simultaneously depress the BAND switch (either UP or DOWN), and the M.IN switch.
3. The display will clear, and only the decimal points will display. All mode indicators will remain off.

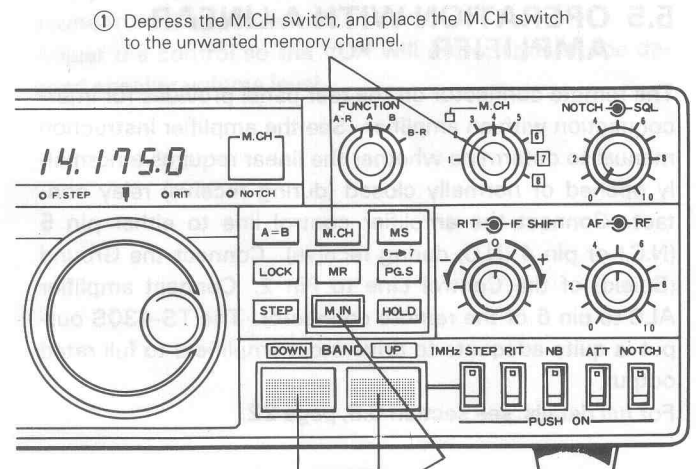

● M.CH (Memory channel) operation

The TS-430S has eight memory channels. The memory permits input of both frequency and mode, and this data will be permanently retained (by the built-in lithium battery).

1. The M.CH switch selects the desired channel from CH 1-8.
2. When the M.IN switch is depressed, a "beep" sounds, indicating memory input.
3. There are two recall modes for memory channel contents.
 - * Depress the M.CH switch. Any one of eight channels can be selected by the M.CH switch as a fixed (non-tunable) frequency and mode.
 - * Depress the MR switch. The channel designated by the M.CH switch is recalled to the VFO for tunable operation. The memory contents are not changed.

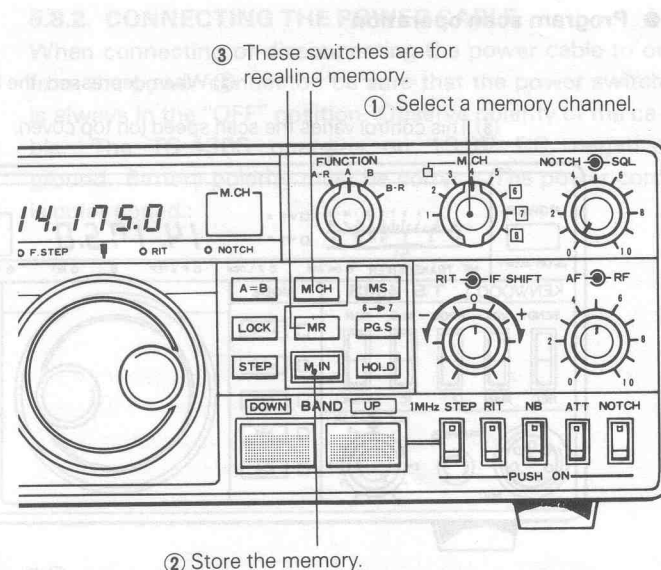

② Store the memory.

● Memory scan operation

1. Input frequencies and modes to be scanned into the memory channels.
2. Depress the MS switch. The channel number and frequency of each occupied channel is displayed. Scan interval is approximately 1.8 seconds per channel.
3. When the desired traffic is received during scan, depress the HOLD switch.
4. Scan will resume by releasing the HOLD switch.

NOTES:

1. The channel eight transmit frequency is not scanned.
2. When memories are empty, [] is displayed and there is no scan.
3. Scan is held by transmitting, and resumes when the transceiver returns to the receive mode.

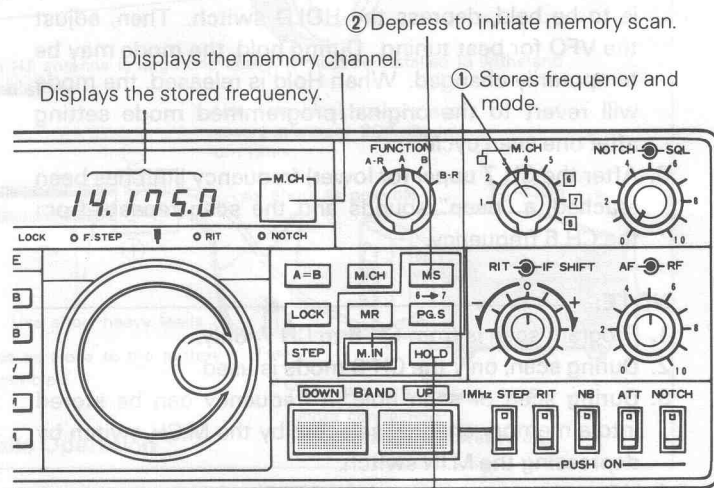

③ Depress when desired traffic is received. Release to resume scan.

● Program scan operation

② When depressed, the letter **P** displays and scan begins.

③ This control varies the scan speed (on top cover).

① Input the lower frequency limit and mode into "6" and the upper frequency limit into "7".

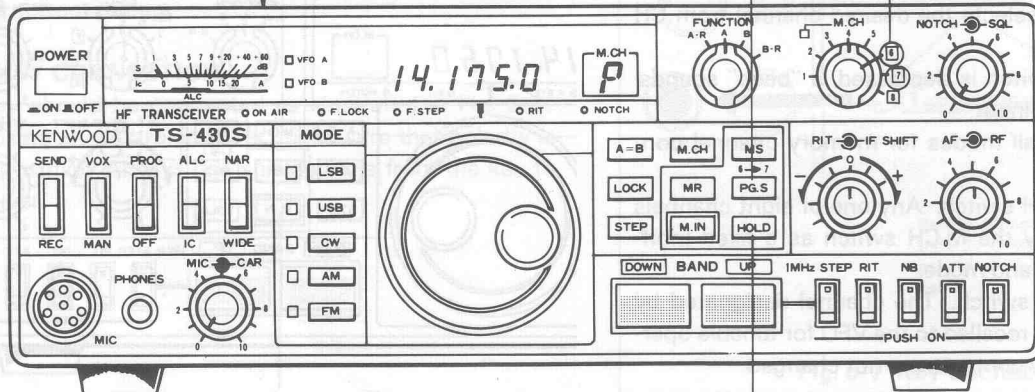

④ Depress to hold a frequency. Turn off to continue scanning.

1. Program the scanning frequency range.
2. Input the lower (or upper) frequency limit and mode into CH 6 (using the M.IN switch). Then, input the upper (or lower) frequency limit into CH 7.
3. Depress the PG.S switch to initiate scan. The letter P will display during program scan.
4. The scan speed is adjustable using the speed control on the top panel, along with the STEP switch. Select the scan speed appropriate for the selected frequency and mode.
5. When the desired station is received and that frequency is to be held, depress the HOLD switch. Then, adjust the VFO for best tuning. During hold, the mode may be temporarily changed. When Hold is released, the mode will revert to the original programmed mode setting after one scan cycle.
6. After the CH 7 upper (or lower) frequency limit has been reached, a "beep" sounds and the scan repeats from the CH 6 frequency.

NOTE:

1. Program scan is from CH 6 to CH 7, only.
2. During scan, only the CH 6 mode is used.
3. During scan or scan hold, a frequency can be stored into a memory channel selected by the M.CH switch by depressing the M.IN switch.
4. When the scan is on and the STEP switch is depressed, the step is 100 Hz.
5. When CH 6 and CH 7 are empty, there can be no scan.
6. Scanning is stopped during transmit and resumed after return to the receive mode.

● Memory CH 8 reception and transmission operation

1. Place the M.CH switch to "8".
2. Input the reception frequency and mode using the M.IN switch.
3. The usual data entry "beep" is emitted as a pulse train. Input the transmission frequency (and mode).
4. The "beep" ceases.
5. Depress the M.CH switch. "Split" frequency operation (transmission and reception on different frequencies are programmed into CH 8.)

NOTE:

1. Different modes and/or bands can also be programmed for transmission and reception.
2. If the M.IN switch is depressed twice in succession, this memory can be used as an ordinary memory, now having the same frequency for both transmission and reception.

③ Pressing this switch TWICE allows transmission and reception on different frequencies.

① Place at "8".

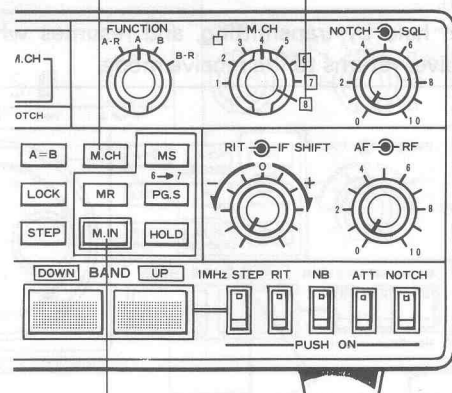

② Input the reception frequency, then the transmit frequency.

5.8 MOBILE OPERATION

Being compact in design, this transceiver is ideal for mobile operation. Satisfactory mobile operation is achieved through proper power and antenna connection, and thoughtful transceiver installation and adjustment.

5.8.1. TS-430S INSTALLATION

Secure the TS-430S under the dashboard using an optional MB-430 mounting bracket as shown in fig. 5-8. As an alternative, use strapping, making sure that the TS-430S will not slip out of place while operating the vehicle.

NOTES:

1. Do not install the TS-430S near the heater outlet.
2. Allow sufficient space behind the TS-430S to ensure proper ventilation.

5.8.2. CONNECTING THE POWER CABLE

When connecting or disconnecting the power cable to or from the power connector, be sure that the power switch is always in the "OFF" position. Observe polarity of the cable. The TS-430S operates on 13.8V DC, negative ground. Battery polarity must be correct. The power cord is color coded:

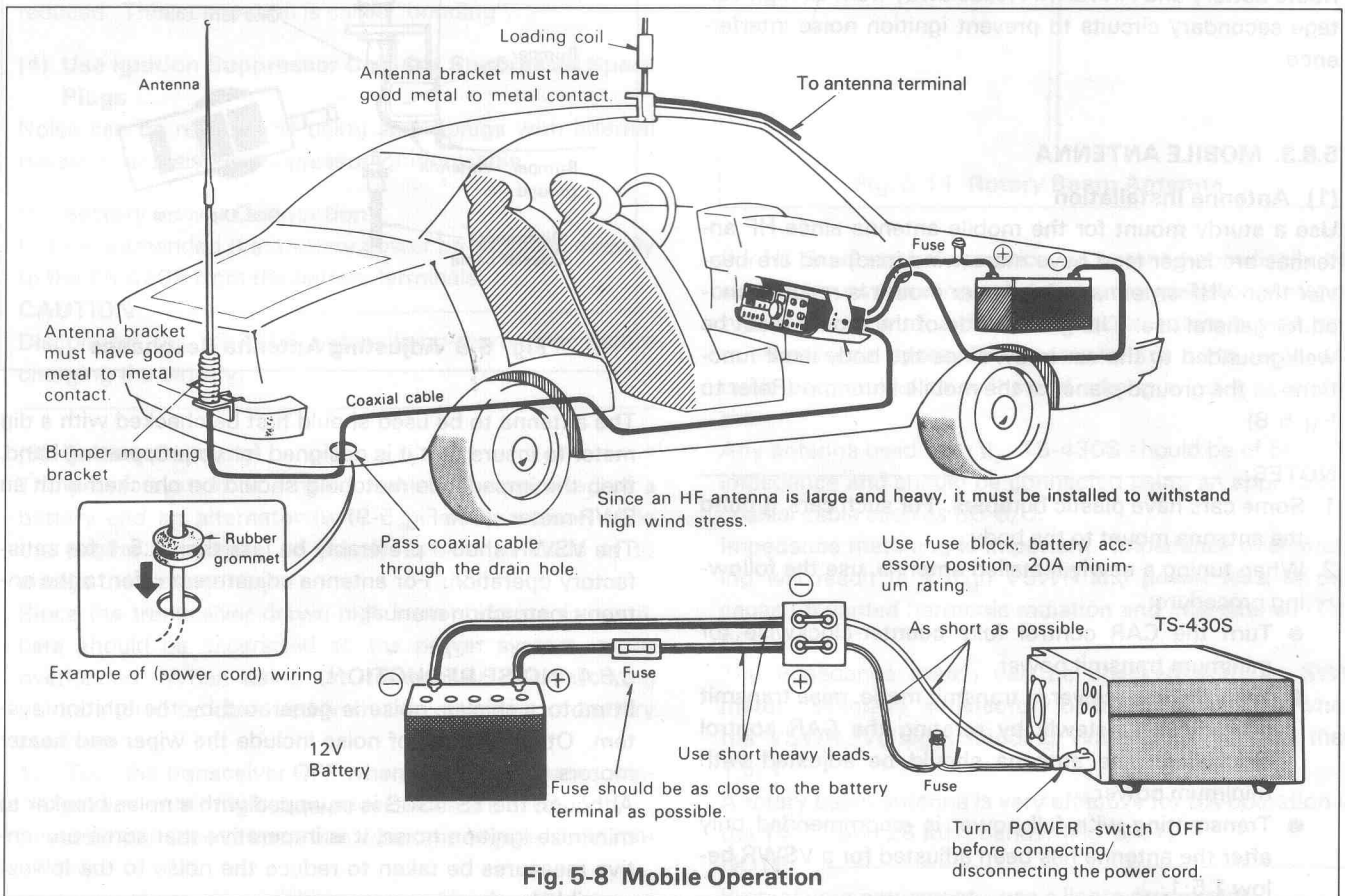

POWER CABLE

CAUTION: Observe battery polarity.

TS-430S
Red and White +
Black and gray -

Connect the TS-430S power cable to the battery terminals, with consideration to current requirements and noise prevention. The maximum current drawn by the TS-430S reaches to between 18 and 20A when transmitting. Therefore, the cable should be made as short as possible, using the specified fuse. Also, determine that the power system of the car (including the battery and generator or alternator) will handle the increased load of the TS-430S.

Route battery and ANTENNA leads away from all high voltage secondary circuits to prevent ignition noise interference.

5.8.3. MOBILE ANTENNA

(1) Antenna Installation

Use a sturdy mount for the mobile antenna since HF antennas are larger (and have more wind load) and are heavier than VHF antennas. A bumper mount is recommended for general use. The ground side of the mount must be well grounded to the car body, since the body itself functions as the ground plane for the mobile antenna. (Refer to Fig. 5-8)

NOTES:

1. Some cars have plastic bumpers. For such cars, ground the antenna mount to the body.
2. When tuning a newly installed antenna, use the following procedure:
 - Turn the CAR control fully counter-clockwise for minimum transmit power.
 - With the transceiver in transmit mode, raise transmit power output slowly by rotating the CAR control clockwise. The antenna should be adjusted with minimum power.
 - Transmitting with full power is recommended only after the antenna has been adjusted for a VSWR below 1.5:1.
3. Antenna installation is critical for successful mobile operation. For further information refer to THE RADIO AMATEUR'S HANDBOOK, RADIO HANDBOOK, or other texts.

(2) Coaxial Cable Connection

When the antenna is mounted on the vehicles bumper, the coaxial cable from the antenna can be routed through a drain hole in the trunk. When the antenna is roof mounted pass the cable between the body and door. Leave a drip-loop at the lowest point in the cable before entry into the vehicle to prevent water from entering the car.

(3) Antenna Adjustment

Some mobile antennas are not designed at 50-ohm impedance. In this case, impedance matching between the antenna and the coaxial cable (50Ω) is required. This can be achieved by using an antenna matching device or coupler.

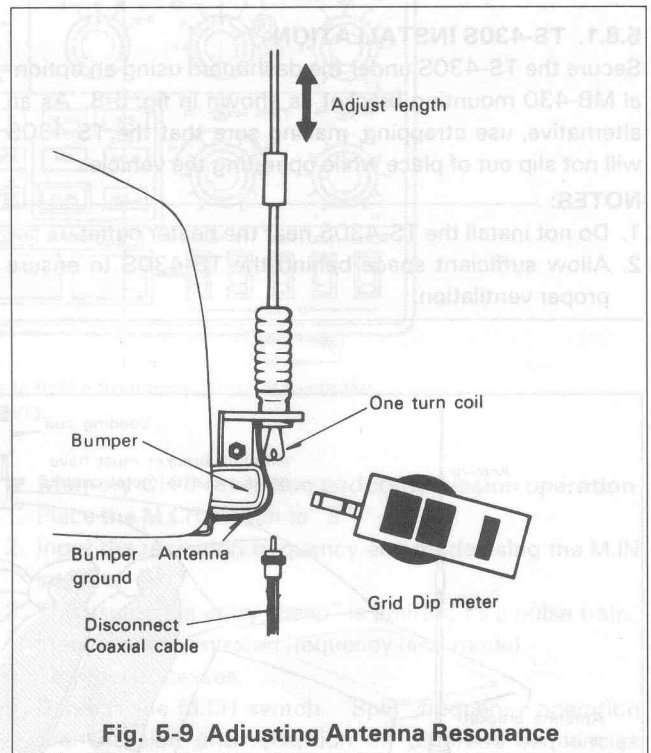

Fig. 5-9 Adjusting Antenna Resonance

The antenna to be used should first be checked with a dip meter to insure that it is designed for your operating band, then the impedance matching should be checked with an SWR meter. (See Fig. 5-9)

The VSWR should preferably be less than 1.5:1 for satisfactory operation. For antenna adjustment refer to the antenna instruction manual.

5.8.4. NOISE REDUCTION

In motor vehicles, noise is generated by the ignition system. Other sources of noise include the wiper and heater motors.

Although the TS-430S is equipped with a noise blanker to minimize ignition noise, it is imperative that some preventive measures be taken to reduce the noise to the lowest possible level.

(1) Antenna location Selection

Since ignition noise is generated by the vehicles engine, the antenna must be installed as far from the engine as possible.

(2) Antenna Matching

In general, mobile antennas have a lower impedance than the 50-ohm coaxial cable used to feed them, resulting in a mismatch between the antenna and the coax. Such trouble can be eliminated by using an antenna tuner between the TS-430S and the coaxial cable.

○ Matching Circuit Examples

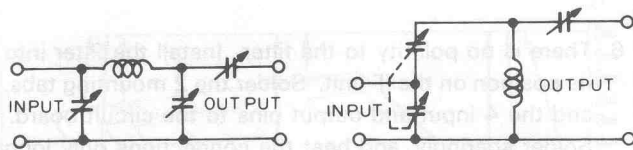

Fig. 5-10 Matching Circuits

(3) Bonding

The component parts of motor vehicles, such as the engine, transmission, muffler system, accelerator, etc., are coupled to one another at DC and low frequencies, but are isolated at high frequencies. By connecting these parts using heavy, braided ground straps, ignition noise can be reduced. This connection is called "bonding".

(4) Use Ignition Suppressor Cable or Suppressor Spark Plugs

Noise can be reduced by using spark plugs with internal resistors, or resistive suppressor ignition cable.

(5) Battery Power Connection

It is recommended that battery power be supplied directly to the TS-430S from the battery terminals.

CAUTION

Disconnect the TS-430S before jump-starting or before charging the battery.

(6) Battery Capacity

The power system of a motor vehicle is comprised of a battery and an alternator (which generates power while the engine is running) to supply current to loads or to charge the battery.

Since the transceiver draws high current during transmit, care should be exercised so the power system is not overloaded. When using the transceiver, the following points should be observed from the viewpoint of battery maintenance:

1. Turn the transceiver OFF when the lights, heater, wipers and other high-draw accessories are used.
2. Avoid transceiver operation when the engine is not running.
3. If necessary, use an ammeter and/or a voltmeter to check battery condition.

5.9 FIXED STATION OPERATION

5.9.1. Power

The TS-430S requires more than 18A at 13.8 VDC when transmitting at full power. Use the model PS-430 power supply for fixed stations.

5.9.2 ANTENNAS

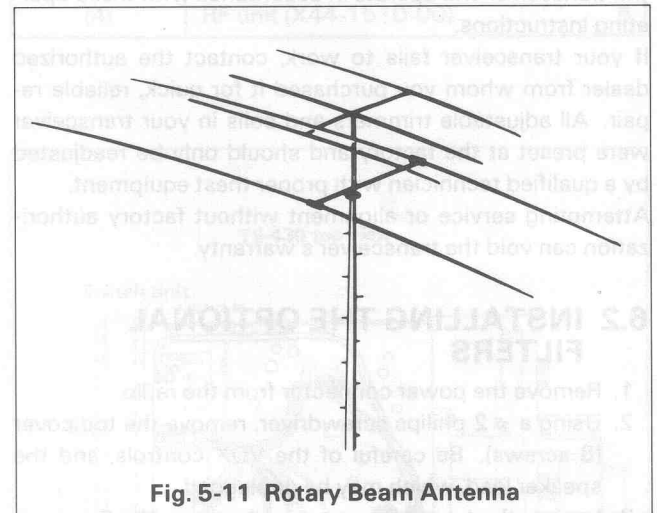

Fig. 5-11 Rotary Beam Antenna

For HF fixed-station operation, an antenna specifically designed for amateur operation is recommended. Antenna types include wire antennas, verticals, rotary beams, and other antenna types. HF antennas are quite large and must be installed to withstand strong wind, heavy rain, etc.

Any antenna used with the TS-430S should be of 50-ohm impedance and should be connected using an appropriate coaxial cable such as RG-8/U.

Impedance matching is important. Impedance mismatching will result in a high VSWR and power loss, or can cause unwanted harmonic radiation and interference (TVI, BCI).

The impedance match can be checked with an SWR meter. Generally, satisfactory operation is assured when the VSWR (Voltage Standing Wave Ratio) is less than 1.5: 1.

A rotary beam antenna is very effective for DX operation in the 14, 21 and 28 MHz bands. (Fig. 5-11)

NOTE:

Protect your equipment – use a lightning arrester.

SECTION 6. ADDITIONAL INFORMATION

6.1 GENERAL INFORMATION

Your TS-430S has been factory aligned and tested to specification before shipment. Under normal circumstances, the transceiver will operate in accordance with these operating instructions.

If your transceiver fails to work, contact the authorized dealer from whom you purchased it for quick, reliable repair. All adjustable trimmers and coils in your transceiver were preset at the factory and should only be readjusted by a qualified technician with proper test equipment.

Attempting service or alignment without factory authorization can void the transceiver's warranty.

6.2 INSTALLING THE OPTIONAL FILTERS

1. Remove the power connector from the radio.
2. Using a #2 philips screwdriver, remove the top cover (8 screws). Be careful of the VOX controls, and the speaker lead, which may be unplugged.
3. Loosen the two side screws and remove the 2 screws securing the IF unit bracket. Swing the bracket up slightly to access and remove the two heat sink screws. Swing the assembly down.
4. Remove 7 screws from the IF unit. Switch the board forward. Protect the top of the front panel from scratching.
5. Using a 45W (or less) soldering pencil, clear the 6 holes for the filter, if they are filled with solder. When installing an AM filter, first remove R129 on the IF unit, and cut the R-129 lead on the Control unit.

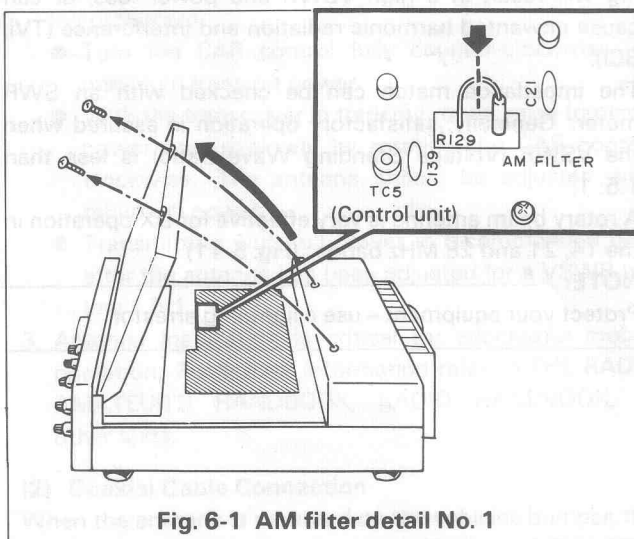

Fig. 6-1 AM filter detail No. 1

6. There is no polarity to the filter. Install the filter into its position on the IF unit. Solder the 2 mounting tabs, and the 4 input and output pins to the circuit board. Solder sparingly, and heat the connections only long enough to insure a good solder joint. Don't overheat the filter or circuit board.
7. Carefully inspect your soldering. Be certain that all pins are actually soldered, and that you have not soldered across any spots on the board or between any of the pins on the filter. Clip the pins flush to the board.
8. Replace the IF unit in its place. Make certain no wires will be pinched underneath the board. Replace the 7 screws for the board, plus the two heat sink screws. Tighten the 2 side screws and replace the 2 rear bracket screws, (See that the wire harness does not interfere with the PG scan speed control).
9. Move the connection as illustrated when an AM filter is installed.
10. Reconnect the speaker lead, and reinstall the top cover.
11. Apply power and verify your work. Filter installation is now complete.

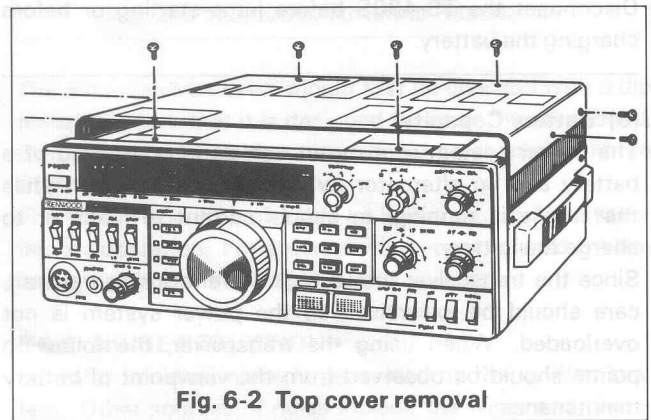

Fig. 6-2 Top cover removal

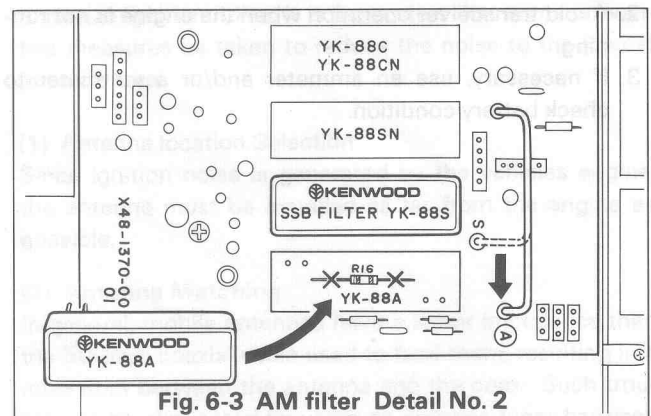

Fig. 6-3 AM filter Detail No. 2

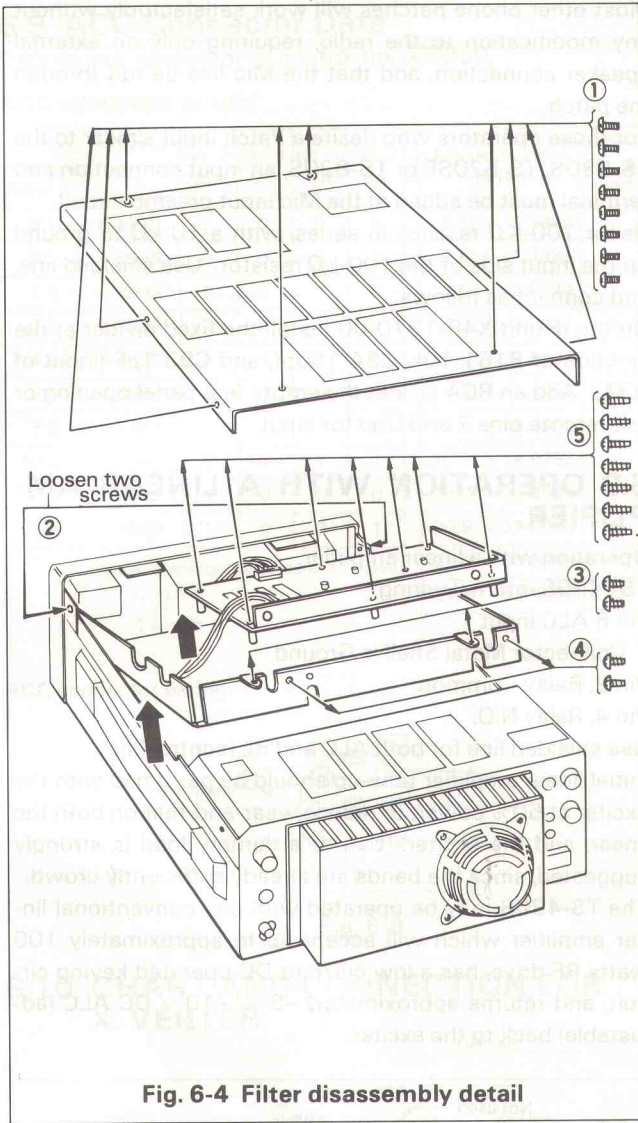

Fig. 6-4 Filter disassembly detail

6.3 OPTIONAL FM-430 INSTALLATION

1. Remove the transceiver top covers and unplug the speaker lead.
2. Mount the FM-430 on the top right side of the transceiver with 6 screws.
3. Connect the FM-430 harness to the transceiver as follows:
 - * Connect the leads from connector (1) to connector (19) of the Switch unit (X41-1470-00).
 - * Connect the leads from connector (3) to connector (24) of the IF unit (X48-1370-00).
 - * Arrange the leads from connectors (2) and (4) on the bottom of the transceiver to pass along the side of the Switch unit. Connect the leads from connector (2) to connector (20) of the RF unit (X44-1510-00). Connect the leads from connector (4) to connector (6) of the RF unit.
4. Tie the leads as illustrated using the supplied vinyl ties.
5. Reinstall the bottom cover, reconnect the speaker lead, and reinstall the top cover.

CONNECTION OF FM-430 CONNECTORS

FM-430 connector No.	Unit and TS-430 connector No.
(1)	Switch unit (X41-1470-00) 19
(2)	RF unit (X44-1510-00) 20
(3)	IF unit (X48-1370-00)..... 24
(4)	RF unit (X44-1510-00) 6

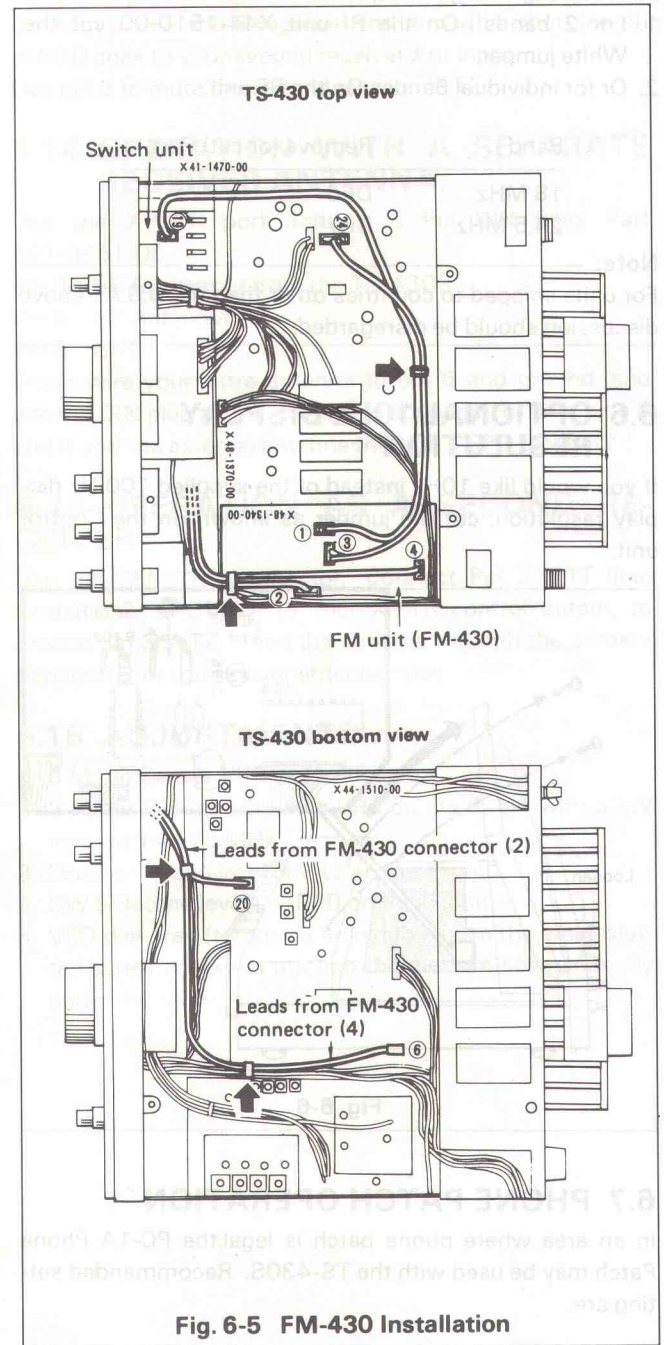

Fig. 6-5 FM-430 Installation

6.4 HOW THE TX FINAL TRANSISTORS ARE PROTECTED

Final transistor protection is provided by sampling the reflected power. As the reflected power is increased (higher SWR) transmitter drive is reduced, thus decreasing input to the final transistors. This in turn reduces collector loss, protecting the final transistors.

6.5 TRANSMITTING ON WARC BANDS

As supplied, the TS-430S will receive but not transmit on the 2 new WARC bands. If transmit capability is desired, a minor wiring change is required.

1. For 2 bands: On the Rf unit X44-1510-00 cut the White jumper.
2. Or for individual Bands: On the RF unit:

Band	Remove (or cut) Part
18 MHz	D66
24.5 MHz	D67

Note:

For units shipped to countries other than the U.S.A., above discussion should be disregarded.

6.6 OPTIONAL 10Hz DISPLAY RESOLUTION

If you would like 10Hz instead of the supplied 100 Hz display resolution, cut the jumper as shown on the Control unit.

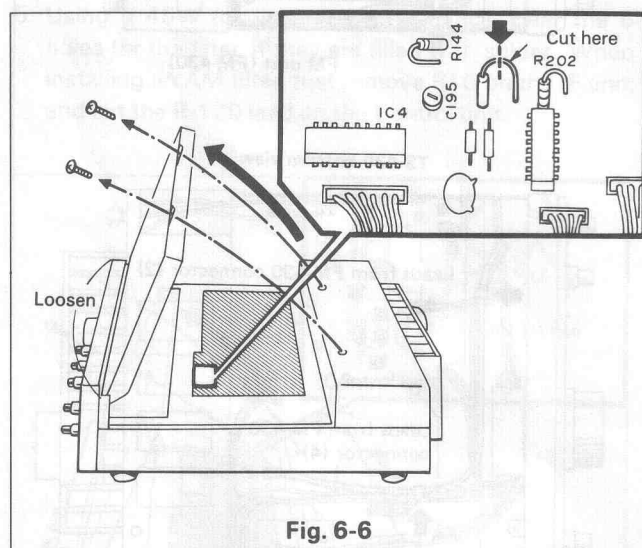

Fig. 6-6

6.7 PHONE PATCH OPERATION

In an area where phone patch is legal, the PC-1A Phone Patch may be used with the TS-430S. Recommended settings are:

PC-1A	RX Gain	4	TS-430S	VOX Gain	1
	TX Gain	4		AF Gain	4
	Null as necessary			Mic Gain	5
				ANTI VOX Max	

Most other phone patches will work satisfactorily without any modification to the radio, requiring only an external speaker connection, and that the Mic line be run through the patch.

For those operators who desire a Patch input similar to the TS-930S, TS-520SE or TS-820S, an input connection and terminal must be added at the Mic input preamp circuit.

Use a 100-K Ω resistor in series, with a 10-k Ω to ground on the input side of the 100-k Ω resistor. Use shielded line, and connect as follows:

On the IF unit X48-1370-00 install the fixed divider at the junction of R161 10k, C94 100pf, and C93 1 μ F (input of Q34). Add an RCA jack at the empty rear panel opening or use remote pins 7 and Gnd for input.

6.8 OPERATION WITH A LINEAR AMPLIFIER.

Operation with a linear amplifier.

TS-430S internal wiring.

Pin 6 ALC input

Connector Metal Shell is Ground

Pin 2, Relay Common

Pin 4, Relay N.O.

Use shielded line for both ALC and RL (control line).

Initial linear amplifier tune-up should be performed with the exciter at 50% power, to reduce wear-and-tear on both the linear, and the exciter. Use of a dummy load is strongly suggested, since the bands are already sufficiently crowd.

The TS-430S may be operated with any conventional linear amplifier which will accept up to approximately 100 watts RF drive, has a low current DC operated keying circuit, and returns approximately -8 ~ -10 V DC ALC (adjustable) back to the exciter.

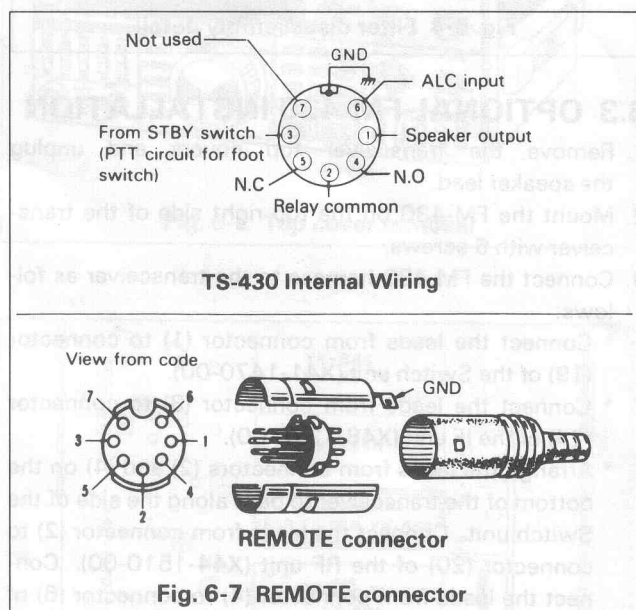

Fig. 6-7 REMOTE connector

PIN	FUNCTION	PIN	FUNCTION
1	Speaker output	5	Relay N.C
2	Relay common	6	ALC input
3	PTT line	7	ALC threshold level approx. -6V
4	Relay N.O.		Not used

6.9 ACC Connector Data

Data output connector to control the AT-250.

ACC connector output

Freq. band [MHz]	PIN No.	No. 2 BD	No. 4 BC	No. 1 BB	No. 7 BA	Frequency band [MHz]	Pin No. 5 WRC
0.15 ~ 0.4999		0	0	0	0	0.15 ~ 1.5999	1
0.5 ~ 1.5999		0	0	0	1	1.6 ~ 1.9999	0
1.6 ~ 2.4999		0	0	1	0	2.0 ~ 2.9999	1
2.5 ~ 3.9999		0	0	1	1	3.0 ~ 3.9999	0
4.0 ~ 6.4999		0	1	0	0	4.0 ~ 6.8999	1
6.5 ~ 7.4999		0	1	0	1	6.9 ~ 7.4999	0
7.5 ~ 10.4999		0	1	1	0	7.5 ~ 13.8999	1
10.5 ~ 15.9999		0	1	1	1	13.9 ~ 14.9999	0
16.0 ~ 22.9999		1	0	0	0	15.0 ~ 20.8999	1
23.0 ~ 29.9999		1	0	0	1	20.9 ~ 21.9999	0
						22.0 ~ 27.8999	1
						27.9 ~ 29.9999	0

Note: Band output data is TTL level.
0 = Low
1 = high

ACC connector wiring

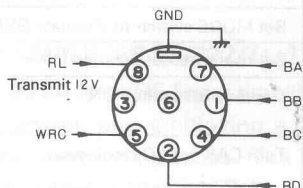
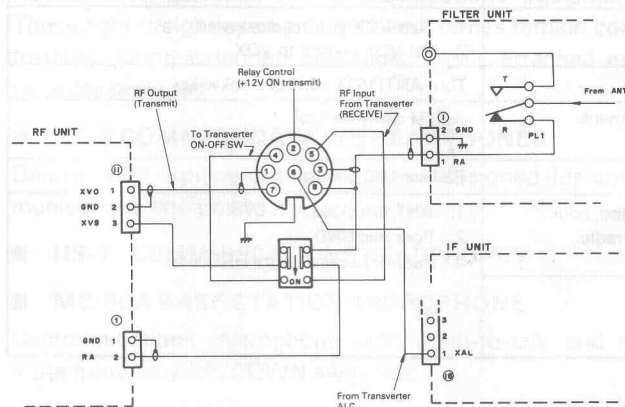

Fig. 6-8

6.10 CHART AND CONNECTION FOR X. VERTER



X VTR Connector

6.11 SSTV or AFSK operation

The TS-430S will adapt to slow scan television or AFSK RTTY operation. For SSTV, the only cabling required are connections between the transceiver microphone input and the camera output, and between the speaker output and the monitor input.

When transmitting, adjust the transmitter output so that final input power is less than approximately 100 W, or for approximately 1/2 of normal output power. For AFSK operation, connect the T.U. output to the microphone input, and speaker output to the T.U. input.

6.12 FRONT BAIL

The transceiver can be elevated for operating convenience by extending the bail.

6.13 OPERATION WITH A SECOND RECEIVER

Use the XVRTR port and an 8 Pin DIN Plug, Part E07-0851-05.

Pin 8 HF Ant output from the TS-430S

Pin 5 RX Ant input

Pin 3 GND

Pin 2 RL control, 12V DC in TX

Connect pins 8 and 5 together and through a short length of 50Ω coax to your second receiver Ant input.

Use pin 2 to mute the second receiver in TX.

6.14 OPERATION WITH A SEPARATE RECEIVER ANTENNA.

Use the XVRTR port and an 8 Pin DIN Plug, Part E07-0851-05

Pin 8 HF Ant output from the TS-430S

Pin 5 RX Ant input

Pin 3 GND

Either wire your extra antenna to pin 5 and ground, and use the DIN plug as the connect/disconnect, or wire pins 8 and 5 and the external antenna through a SPDT switch.

6-15 OPERATION AS A SECOND RECEIVER

Use the REMOTE Connector. Connect Pin 3 (PTT line) (and Pin 2, GROUND) to your XMTR control output, to ground Pin 3 in TX. Feed the antenna through the primary transmitter or transceiver antenna relay.

6.16 ADJUSTMENTS

1. S Meter Zero is VR2 on the IF unit.
2. S meter S-9 calibration is VR3 on the IF, set with 50μV input at 14.175 MHz.
3. "Beeper" audio level is VR6 on the IF unit.
4. CW Sidetone level is VR10 on the IF unit.
5. VFO dial drag (torque) is adjustable from the small slotted screw accessed through the bottom cover, directly under the VFO.

SECTION 7. TROUBLE SHOOTING

The problems described in this table are failures caused in general by improper operation or connection of the transceiver, not by defective components.

There is a separate Service Manual for repair of the Transceiver.

TRANSMITTER AND RECEIVER CIRCUITS

SYMPTOMS	CAUSE	REMEDY
Pilot lights do not light and there is no receiver noise when the POWER switch is turned on.	<ol style="list-style-type: none"> 1. Power cord disconnected or AC power OFF. 2. Loose power connector. 3. Blown fuse. 4. PS-430 POWER switch OFF. 	<ol style="list-style-type: none"> 1. Connect power cord. Turn AC power ON. 2. Reconnect. 3. Replace fuse (If fuse blows again, contact service station.) 4. Turn ON the PS-430 power switch.
RECEIVER SECTION		
No signals received with antenna connected.	Standby or microphone PTT switch is in transmit position.	Place switch in receive position.
S-meter deflects without signals.	<ol style="list-style-type: none"> 1. Power supply voltage is too low. 2. RF gain is too low. 	<ol style="list-style-type: none"> 1. Adjust voltage to 13.8V DC (12 ~ 16V DC). Reset voltage selector to correct local AC line voltage (PS-430). 2. Turn RF GAIN control fully clockwise.
SSB signal unintelligible.	Wrong sideband.	Set MODE switch to alternate SSB position.
SSB received signal is high or low cut.	IF SHIFT is out of adjustment.	Set to the center position (click).
Frequency remains the same when RIT control is adjusted	RIT switch is OFF.	Depress RIT switch ON.
No output.	Standby switch not in transmit position. CAR or MIC control in minimum position.	Turn CAR or MIC clockwise.
No SSB output.	<ol style="list-style-type: none"> 1. MIC plug loose. 2. MIC control in minimum position. 	<ol style="list-style-type: none"> 1. Reconnect. 2. Turn MIC control clockwise.
FMing in sideband operation.	Unstable or insufficient Power Supply.	Adjust voltage to 13.8V DC (12 ~ 16V DC). Reset voltage selector to correct local AC line voltage (PS-430).
VOX circuit inoperative	<ol style="list-style-type: none"> 1. VOX control in minimum position. 2. VOX switch in MAN position. 	<ol style="list-style-type: none"> 1. Turn VOX control clockwise. 2. Set VOX switch to VOX.
VOX operates by sound from speaker.	ANTI VOX setting incorrect.	Turn ANTI VOX control clockwise.
VOX circuit releases between words or holds too long.	VOX time hold control requires adjustment.	Adjust delay control.
Signal reports of distortion	Too much microphone gain.	Reduce MIC control.
Mic or radio chassis is "hot" during TX.	Excess RF in the shack. No earth ground, poor ground, or antenna is too close to the radio.	<ol style="list-style-type: none"> 1. ANT too close to X CVR. 2. Poor mic GND. 3. Poor or excess length GND less.
Poor audio in SSB	TX-feedback Excess RF in the shack.	

SECTION 8. OPTIONAL ACCESSORIES

The following optional accessories are available for use with the TS-430S.

■ SP-430 EXTERNAL SPEAKER

The SP-430 is an external speaker designed exclusively for use with the TS-430S. It matches the transceiver in design and tone quality.

■ SP-40: MOBILE SPEAKER

■ PS-430 REGULATED DC POWER SUPPLY

The PS-430 is a regulated DC power supply with high current capability. The output is 13.8 VDC/20A (intermittent). Since terminals for 13.8 VDC/10A are also provided, in addition to an output power cable for use with the TS-430S, the PS-430 can also be used as the power source for another low power mobile transceiver such as a 2-meter rig.

■ FM-430: FM UNIT

■ AT-250

■ HF LINEAR AMPLIFIER TL-922/TL-922A

The TL-922/TL-922A is an HF linear amplifier operating at maximum legal power, and employing a pair of 3-500Z high performance transmitting tubes. The TL-922A (without 10m band) is available only in U.S.A.

■ HS-4: HEADPHONES

■ HS-5 COMMUNICATIONS HEADPHONES

Headphones designed for communications equipment. These light-weight open air-type headphones remain comfortable during extended operation. Easily attached ear-pads are provided.

■ HS-6 COMMUNICATIONS HEADPHONES

Deluxe, very lightweight headphones designed for communications equipment.

■ HS-7: COMMUNICATIONS HEADPHONES

■ MC-60A BASE STATION MICROPHONE

Communications microphone with push-to-talk and remote frequency UP/DOWN switches.

■ HC-10: DIGITAL WORLD CLOCK

The HC-10 is a highly advanced world clock with dual displays which can memorize 10 preset world major cities and 2 additional programmable regions.

■ MB-430 MOBILE MOUNT

Mobile mount designed for the TS-430S. It allows easy installation and removal the transceiver.

The MB-430 can either be suspended from the dashboard or attached to the transmission tunnel or a center console. The transceiver tilt angle can be adjusted 5 steps.

■ MC-42S: MICROPHONE (8 pin plug)

SP-430



PS-430

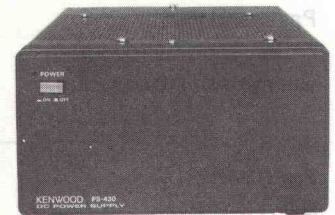

AT-250



HS-5



HS-6

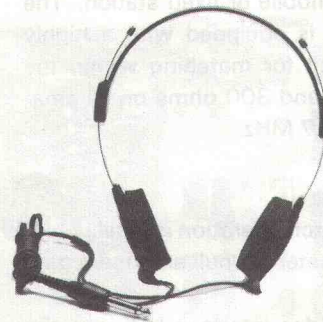

MC-60A



HC-10

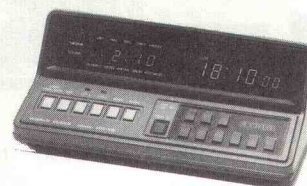

MB-430

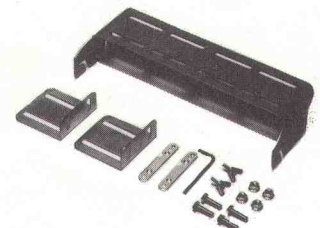

**Filter Options
For AM**

■ **YK-88A**

Center Frequency : 8,831.5 kHz
 Passband Width : 6 kHz (-6 dB)
 Attenuation Bandwidth : 11 kHz (-60 dB)
 Guaranteed Attenuation : More than 80 dB

For CW

■ * **YK-88C**

Center Frequency : 8,830.7 kHz
 Passband Width : 500 Hz (-6 dB)
 Attenuation Bandwidth : 1.5 kHz (-60 dB)
 Guaranteed Attenuation : More than 80 dB

For CW

■ **YK-88CN**

Center Frequency : 8,830.7 kHz
 Passband Width : 270 Hz (-6 dB)
 Attenuation Bandwidth : 1.1 kHz (-60dB)
 Guaranteed Attenuation : More than 80 dB

For SSB

■ **YK-88SN**

Center Frequency : 8,830.0 kHz
 Passband Width : 1.8 kHz (-6 dB)
 Attenuation Bandwidth : 3.3 kHz (-60 dB)
 Guaranteed Attenuation : More than 80 dB

■ **Model AT-130 Antenna Tuner**

The AT-130 is a compact antenna tuner designed for use with the TS-430S in either a mobile or fixed station. The SWR meter is illuminated. It is equipped with a highly accurate SWR detecting circuit for matching within the impedance range between 20 and 300 ohms on all amateur bands between 3.5 and 29.7 MHz.

■ **PC-1A: PHONE PATCH**

(Available only where phone patch operation is legal.)
 Hybrid phone patch with VU meter for null and audio gain measurements.

The PC-1A Phone Patch provides interface between the transceiver and telephone line.

Providing excellent performance, it is designed with high isolation between receive input and transmit output.

Its compact design permits easy installation in a limited space.

(FCC Part 68 registered)

YK-88A



YK-88C



YK-88CN



YK-88SN



AT-130



SECTION 9 INTERNAL VIEWS

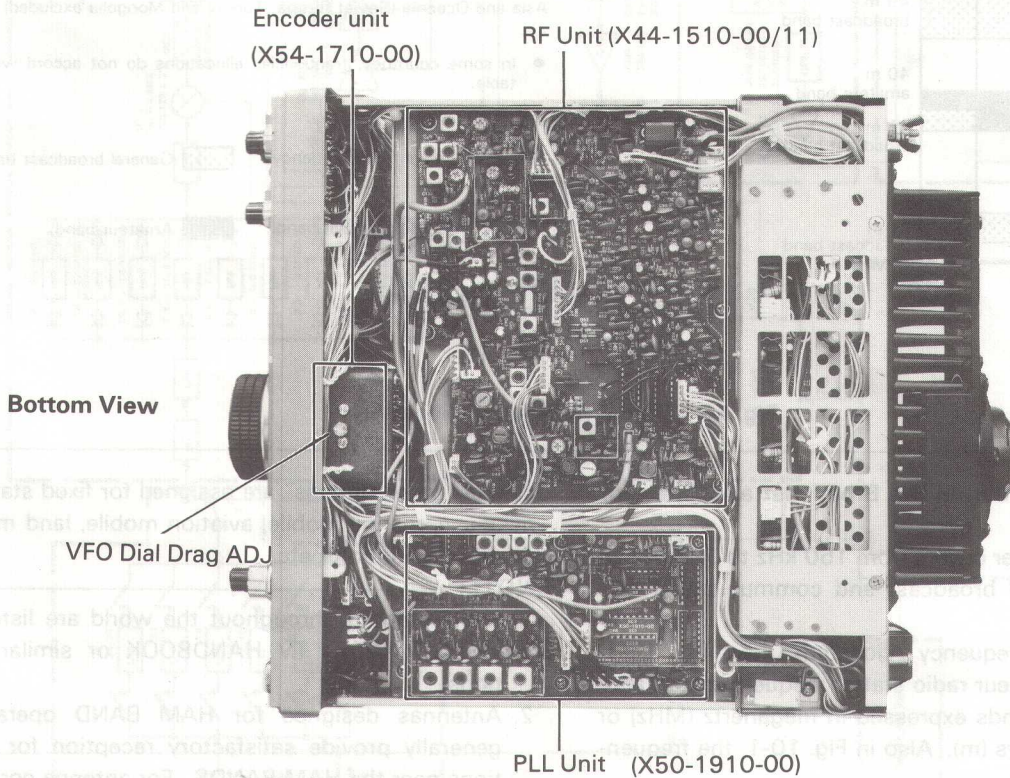
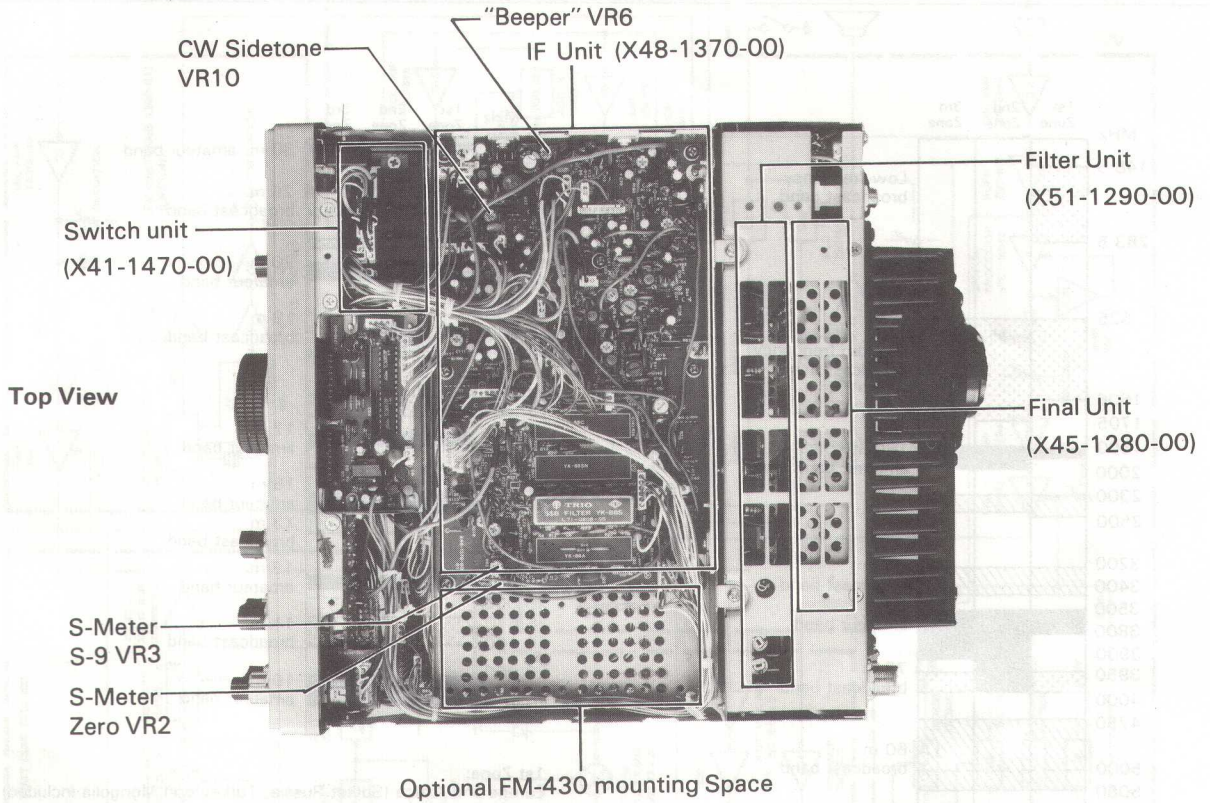

Section 10 RADIO FREQUENCY ALLOCATION

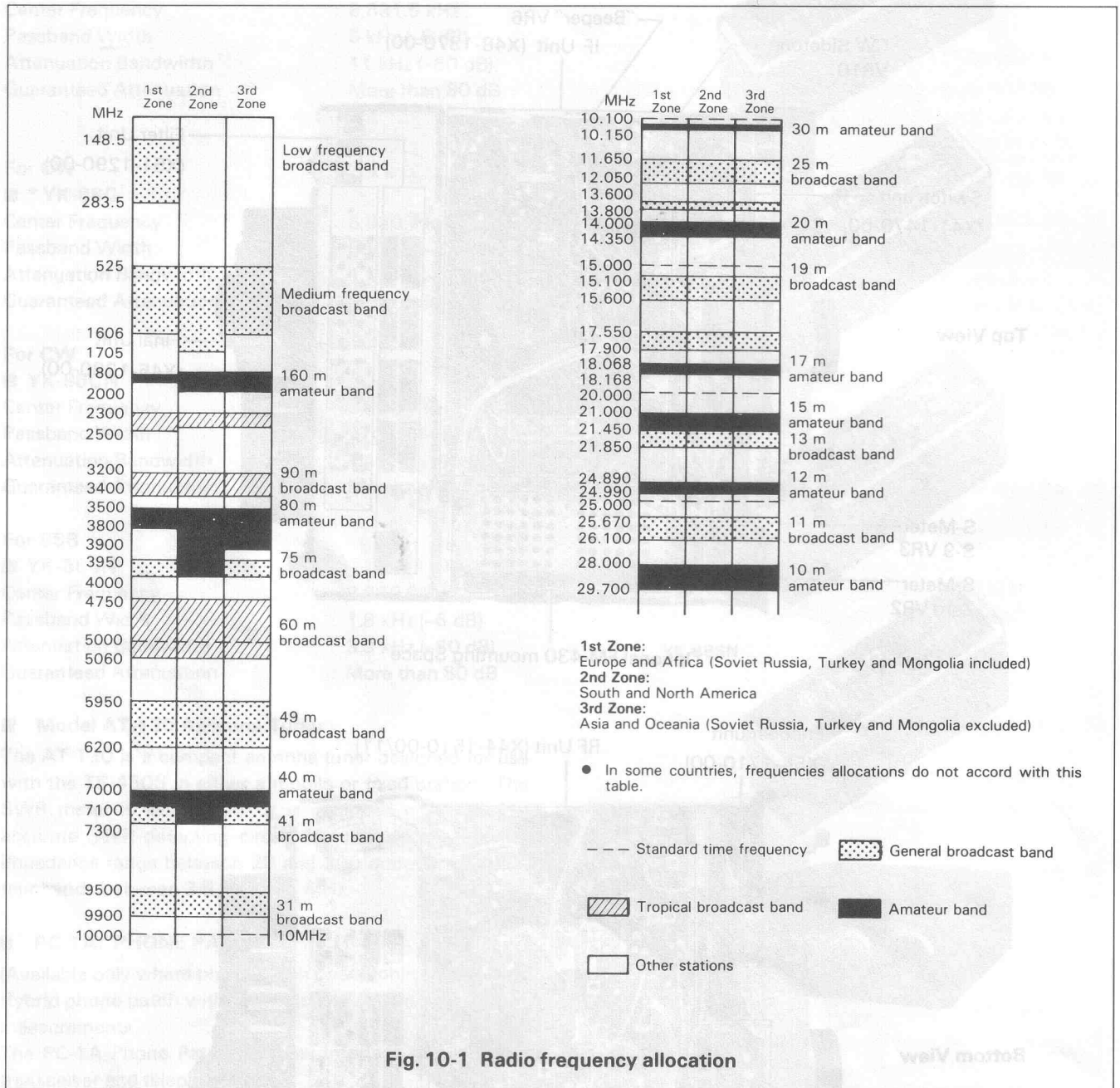

Fig. 10-1 Radio frequency allocation

Frequency Distribution in the Broadcast and Amateur Bands.

The TS-430S receiver covers from 150 kHz to 30 MHz, to receive international broadcast and communication services.

As shown in the Frequency Allocation Chart, Fig. 10-1, broadcast and Amateur radio station frequencies are allocated in specific bands expressed in megahertz (MHz) or wavelength in meters (m). Also in Fig. 10-1, the frequen-

cies of "other stations" are assigned for fixed station business use, marine mobile, aviation mobile, land mobile, radio beacon stations, etc.

NOTE:

1. Radio stations throughout the world are listed in the **WORLD RADIO TV HANDBOOK** or similar publications.
2. Antennas designed for HAM BAND operation will generally provide satisfactory reception for SW stations near the HAM BANDS. For antenna construction details, see the **ARRL ANTENNA HANDBOOK**, or similar publications.

BLOCK DIAGRAM

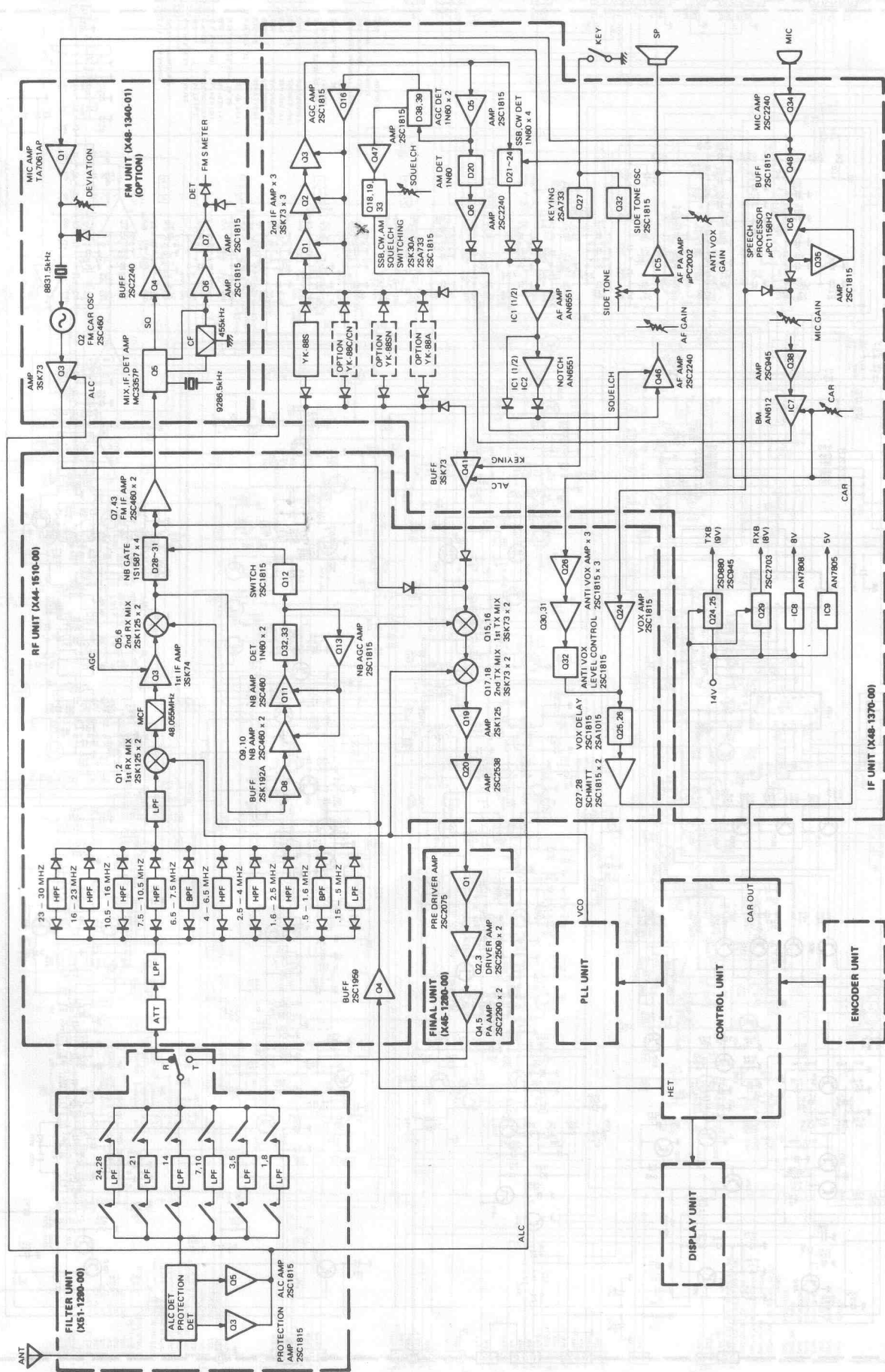

RF UNIT (X44-1510-11)

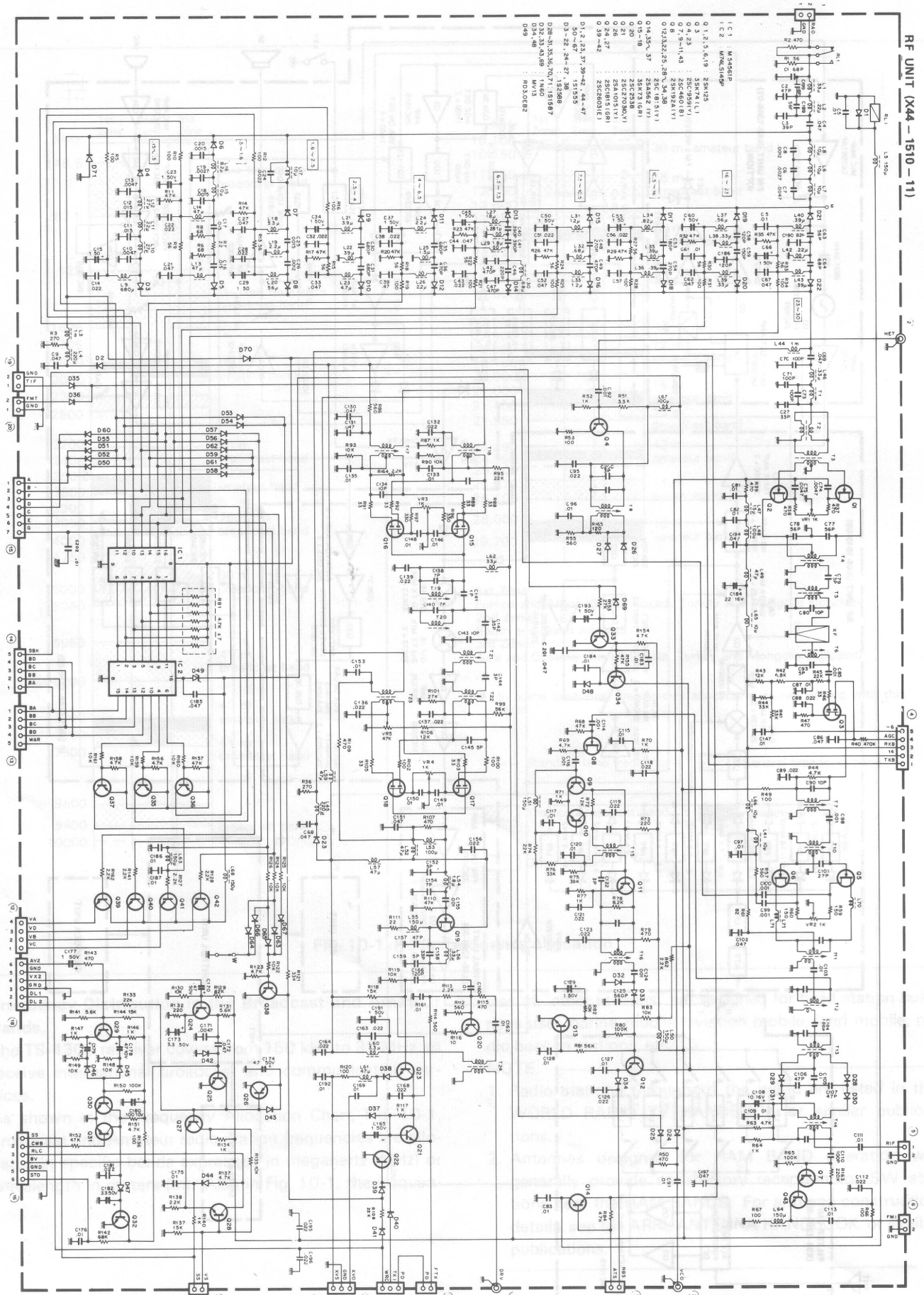

- IC1 M4560P
- IC2 M4560P
- Q1 2N3638
- Q2 2N3638
- Q3 2N3638
- Q4 2N3638
- Q5 2N3638
- Q6 2N3638
- Q7 2N3638
- Q8 2N3638
- Q9 2N3638
- Q10 2N3638
- Q11 2N3638
- Q12 2N3638
- Q13 2N3638
- Q14 2N3638
- Q15 2N3638
- Q16 2N3638
- Q17 2N3638
- Q18 2N3638
- Q19 2N3638
- Q20 2N3638
- Q21 2N3638
- Q22 2N3638
- Q23 2N3638
- Q24 2N3638
- Q25 2N3638
- Q26 2N3638
- Q27 2N3638
- Q28 2N3638
- D1 2N3638
- D2 2N3638
- D3 2N3638
- D4 2N3638
- D5 2N3638
- D6 2N3638
- D7 2N3638
- D8 2N3638
- D9 2N3638
- D10 2N3638
- C1 100K
- C2 100K
- C3 100K
- C4 100K
- C5 100K
- C6 100K
- C7 100K
- C8 100K
- C9 100K
- C10 100K
- C11 100K
- C12 100K
- C13 100K
- C14 100K
- C15 100K
- C16 100K
- C17 100K
- C18 100K
- C19 100K
- C20 100K
- C21 100K
- C22 100K
- C23 100K
- C24 100K
- C25 100K
- C26 100K
- C27 100K
- C28 100K
- C29 100K
- C30 100K
- C31 100K
- C32 100K
- C33 100K
- C34 100K
- C35 100K
- C36 100K
- C37 100K
- C38 100K
- C39 100K
- C40 100K
- C41 100K
- C42 100K
- C43 100K
- C44 100K
- C45 100K
- C46 100K
- C47 100K
- C48 100K
- C49 100K
- C50 100K
- C51 100K
- C52 100K
- C53 100K
- C54 100K
- C55 100K
- C56 100K
- C57 100K
- C58 100K
- C59 100K
- C60 100K
- C61 100K
- C62 100K
- C63 100K
- C64 100K
- C65 100K
- C66 100K
- C67 100K
- C68 100K
- C69 100K
- C70 100K
- C71 100K
- C72 100K
- C73 100K
- C74 100K
- C75 100K
- C76 100K
- C77 100K
- C78 100K
- C79 100K
- C80 100K
- C81 100K
- C82 100K
- C83 100K
- C84 100K
- C85 100K
- C86 100K
- C87 100K
- C88 100K
- C89 100K
- C90 100K
- C91 100K
- C92 100K
- C93 100K
- C94 100K
- C95 100K
- C96 100K
- C97 100K
- C98 100K
- C99 100K
- C100 100K
- R1 100K
- R2 100K
- R3 100K
- R4 100K
- R5 100K
- R6 100K
- R7 100K
- R8 100K
- R9 100K
- R10 100K
- R11 100K
- R12 100K
- R13 100K
- R14 100K
- R15 100K
- R16 100K
- R17 100K
- R18 100K
- R19 100K
- R20 100K
- R21 100K
- R22 100K
- R23 100K
- R24 100K
- R25 100K
- R26 100K
- R27 100K
- R28 100K
- R29 100K
- R30 100K
- R31 100K
- R32 100K
- R33 100K
- R34 100K
- R35 100K
- R36 100K
- R37 100K
- R38 100K
- R39 100K
- R40 100K
- R41 100K
- R42 100K
- R43 100K
- R44 100K
- R45 100K
- R46 100K
- R47 100K
- R48 100K
- R49 100K
- R50 100K
- R51 100K
- R52 100K
- R53 100K
- R54 100K
- R55 100K
- R56 100K
- R57 100K
- R58 100K
- R59 100K
- R60 100K
- R61 100K
- R62 100K
- R63 100K
- R64 100K
- R65 100K
- R66 100K
- R67 100K
- R68 100K
- R69 100K
- R70 100K
- R71 100K
- R72 100K
- R73 100K
- R74 100K
- R75 100K
- R76 100K
- R77 100K
- R78 100K
- R79 100K
- R80 100K
- R81 100K
- R82 100K
- R83 100K
- R84 100K
- R85 100K
- R86 100K
- R87 100K
- R88 100K
- R89 100K
- R90 100K
- R91 100K
- R92 100K
- R93 100K
- R94 100K
- R95 100K
- R96 100K
- R97 100K
- R98 100K
- R99 100K
- R100 100K

TS-430S IF UNIT (X48-1370-00)

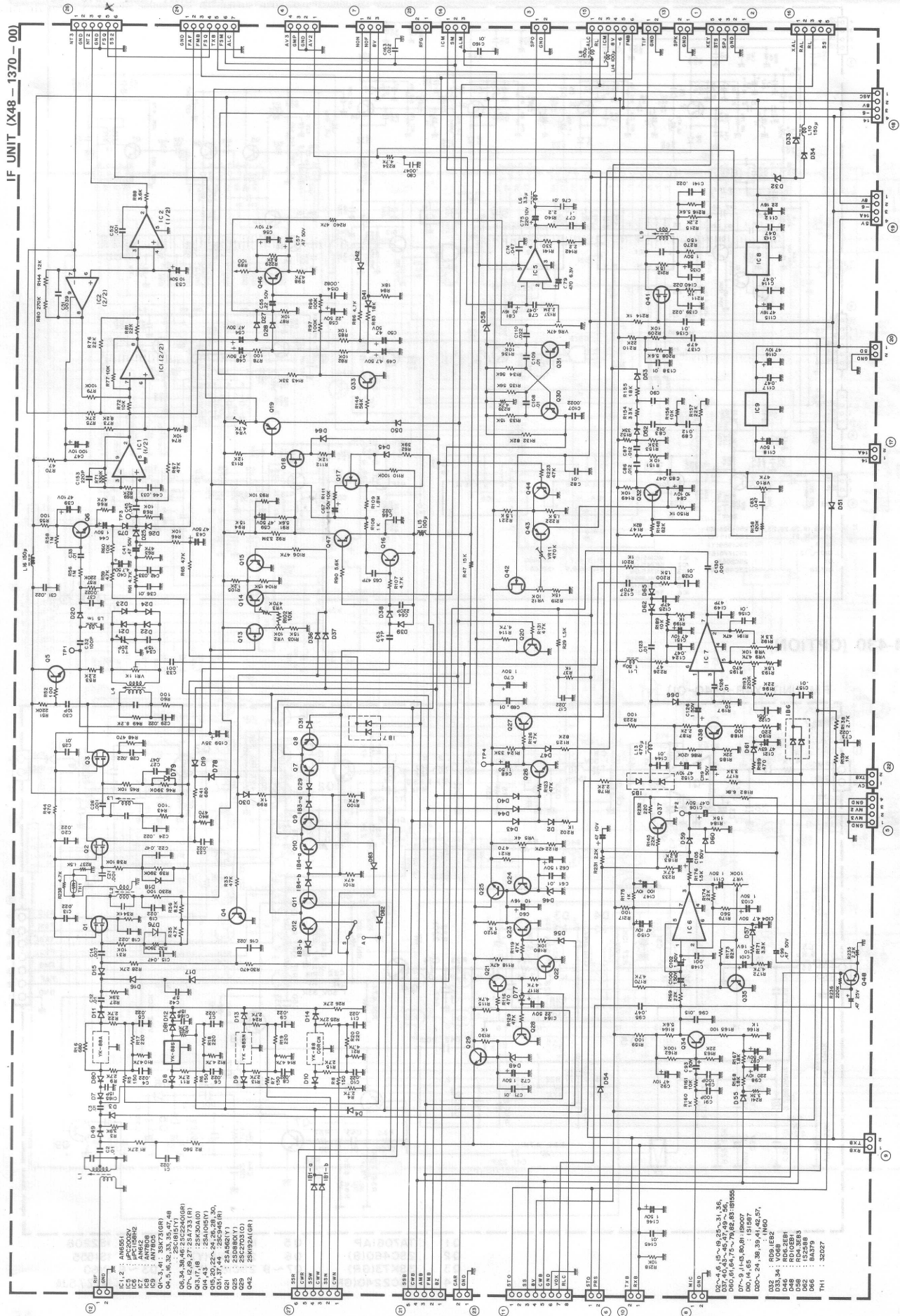

TS-430S PLL UNIT (X50-1910-00)

PLL UNIT (X50-1910-00)

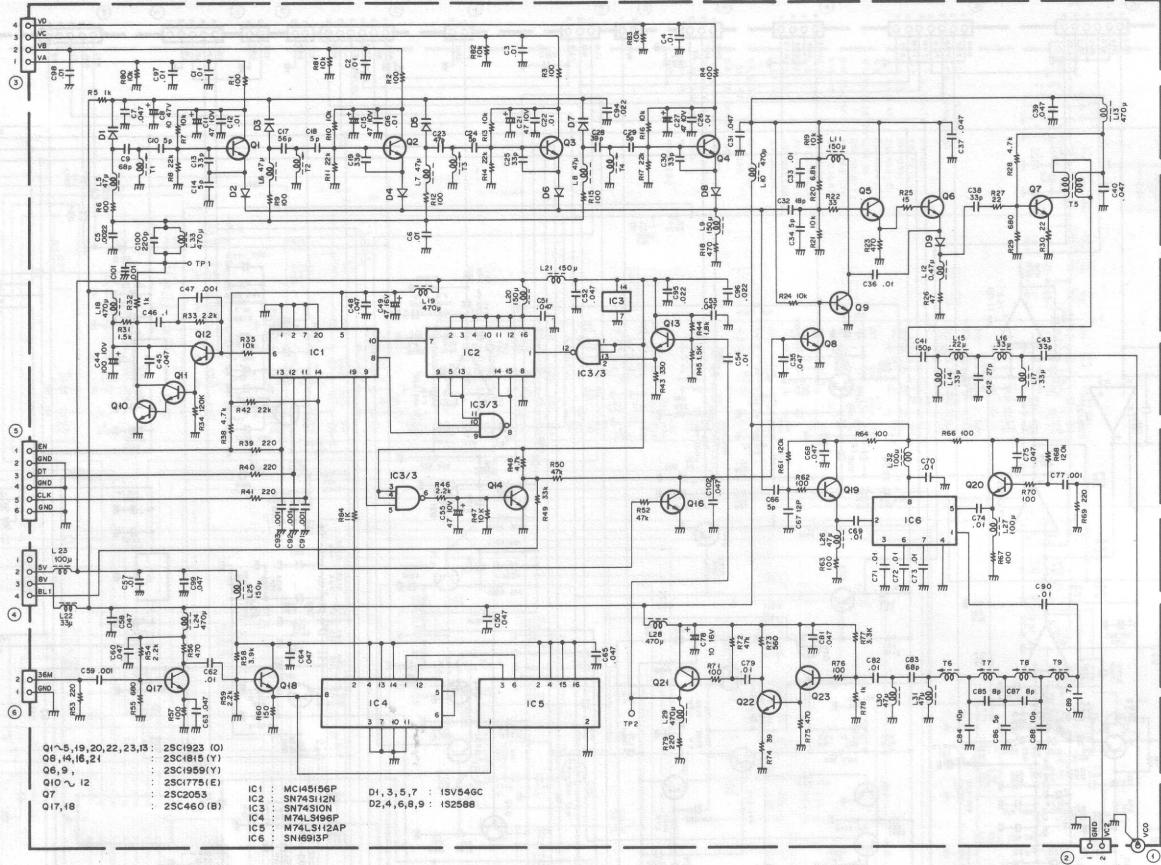

FM-430 (OPTION)

FM UNIT (X48-1340-01)

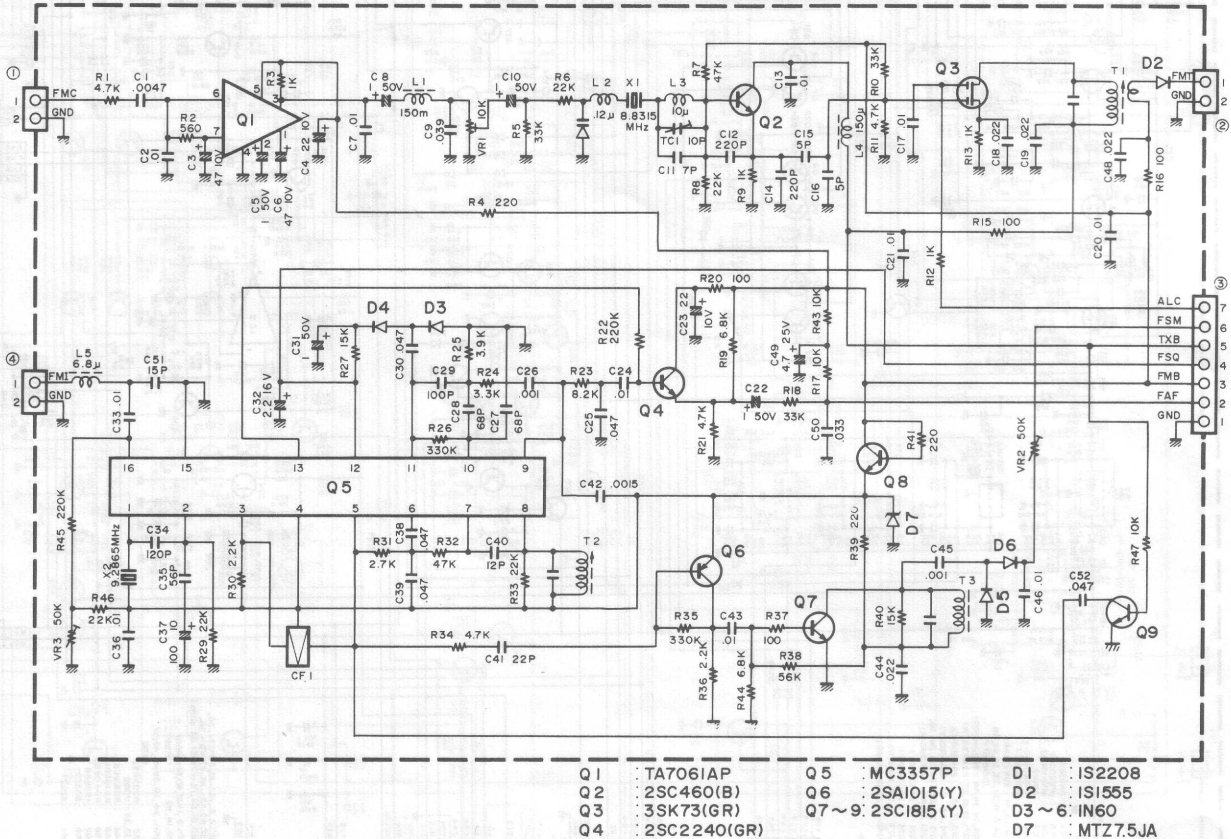

TS-430S SCHEMATIC DIAGRAM

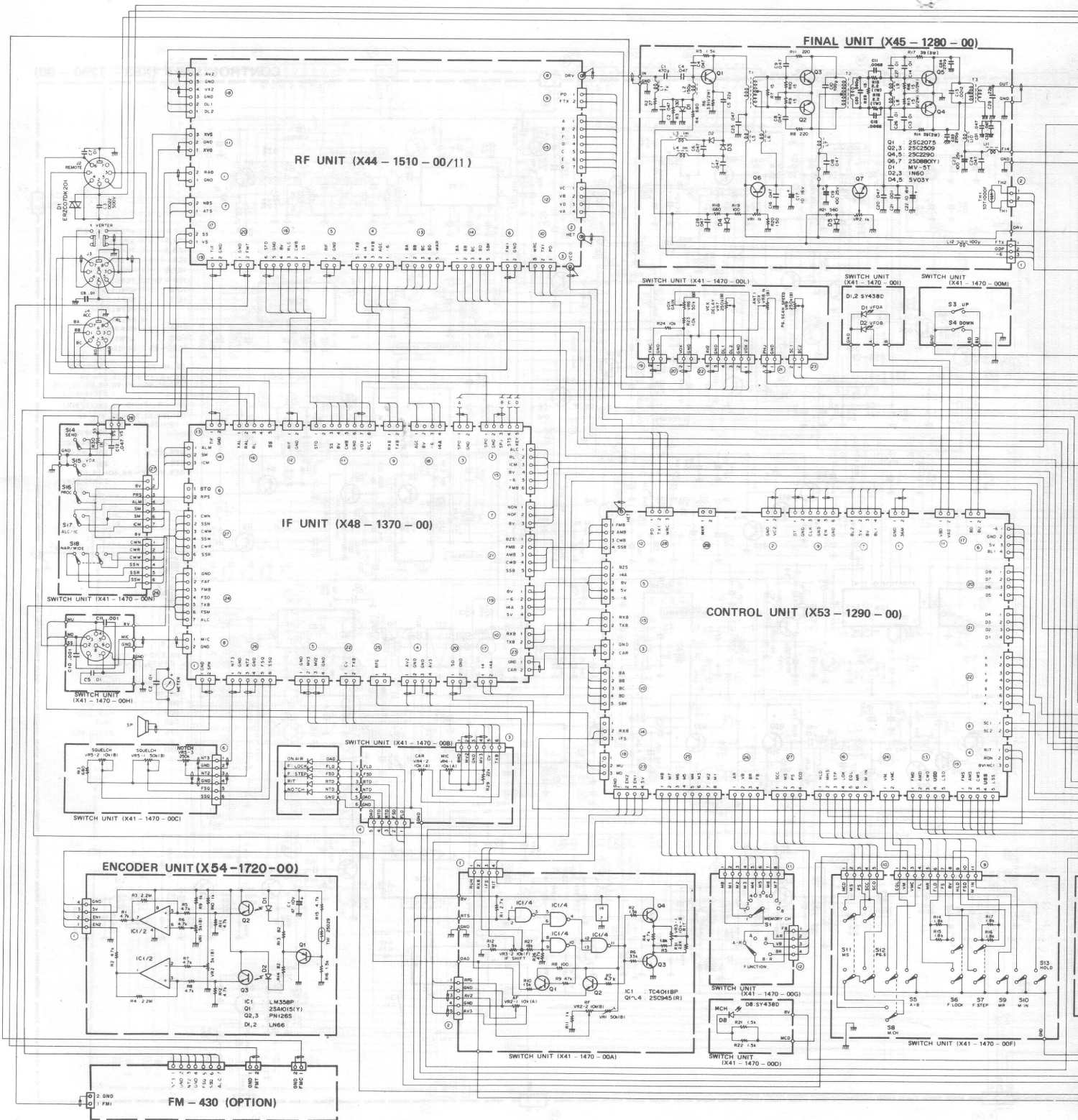

FILTER UNIT (X51 - 1290 - 00)

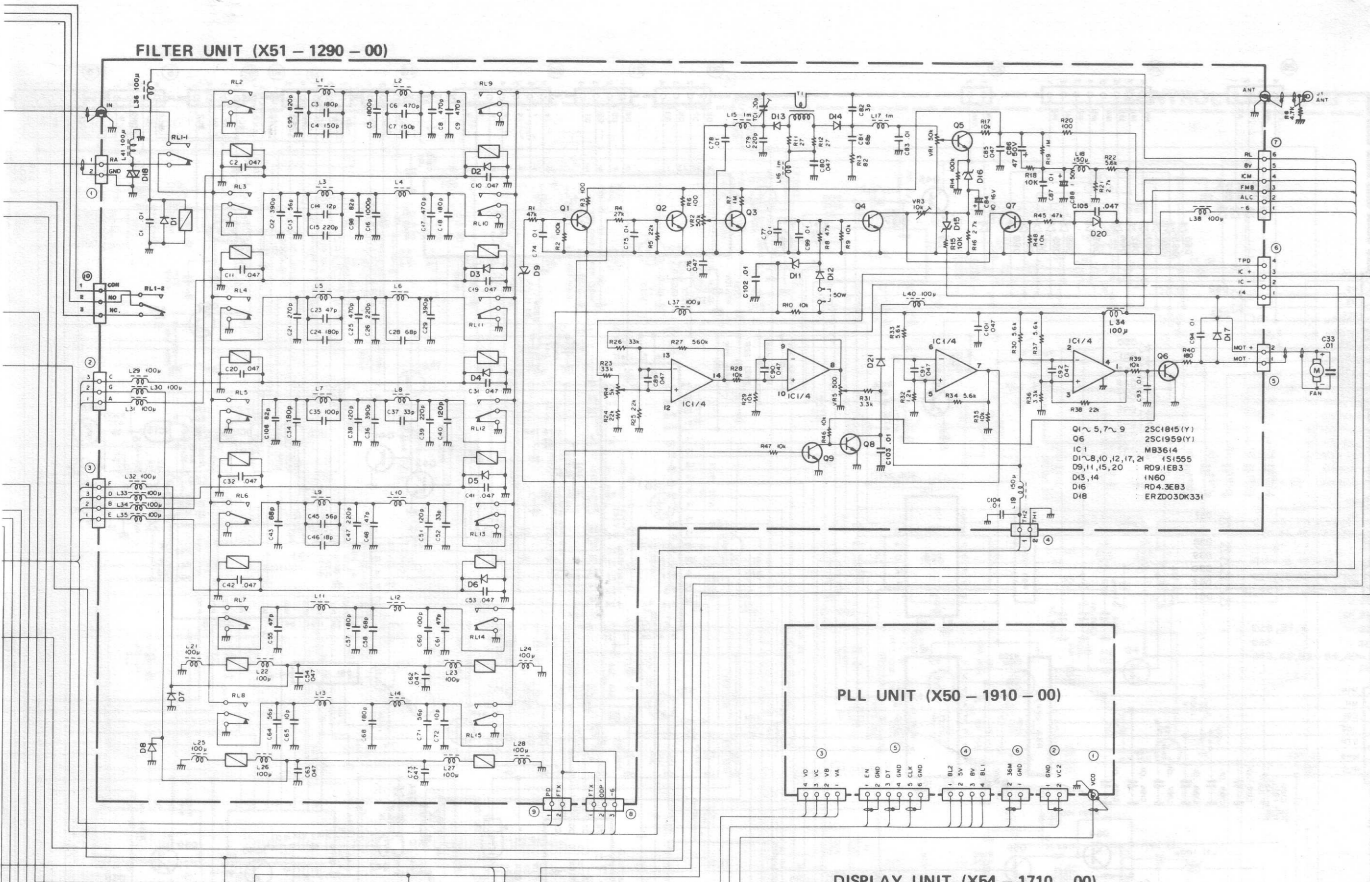

PLL UNIT (X50 - 1910 - 00)

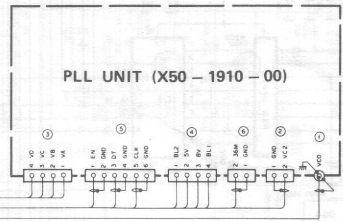

DISPLAY UNIT (X54 - 1710 - 00)

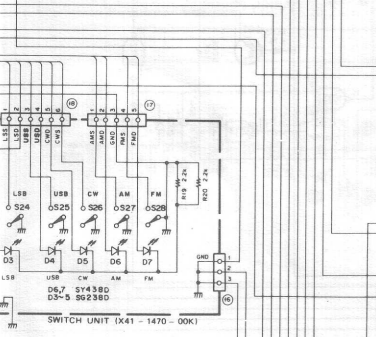
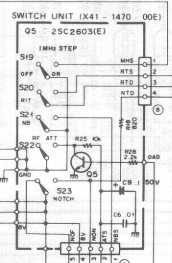
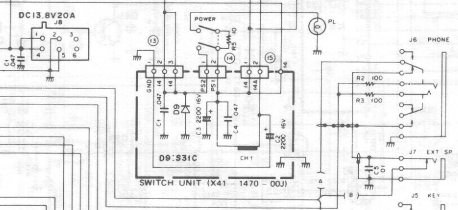
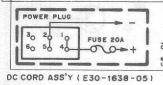
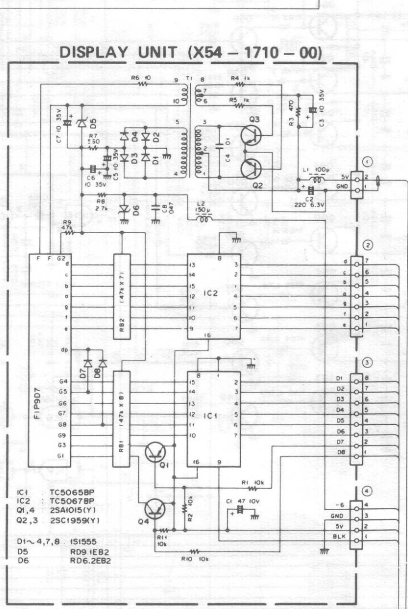

TS-430S SCHEMATIC DIAGRAM

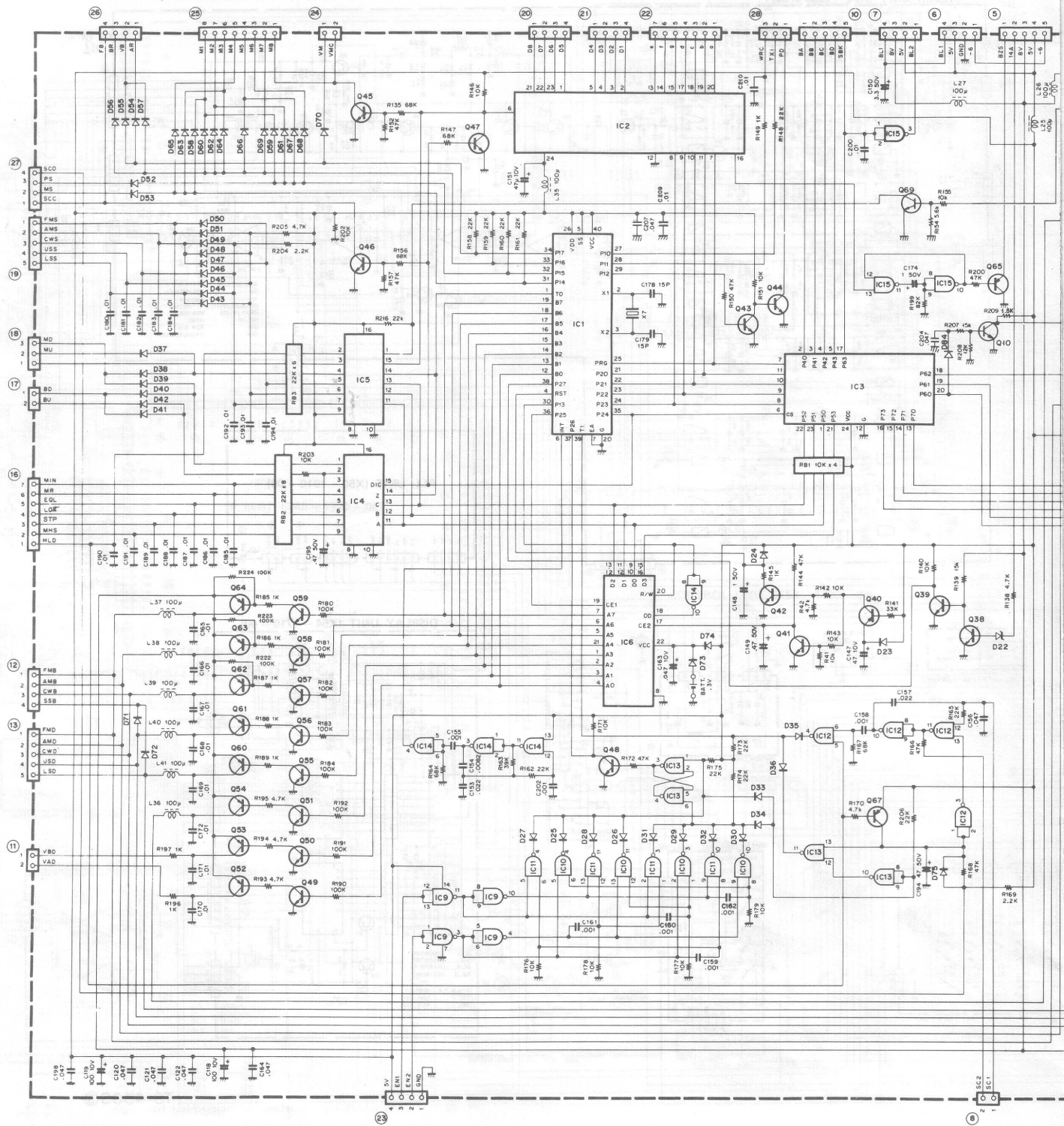

CONTROL UNIT (X53 - 1290 - 00)

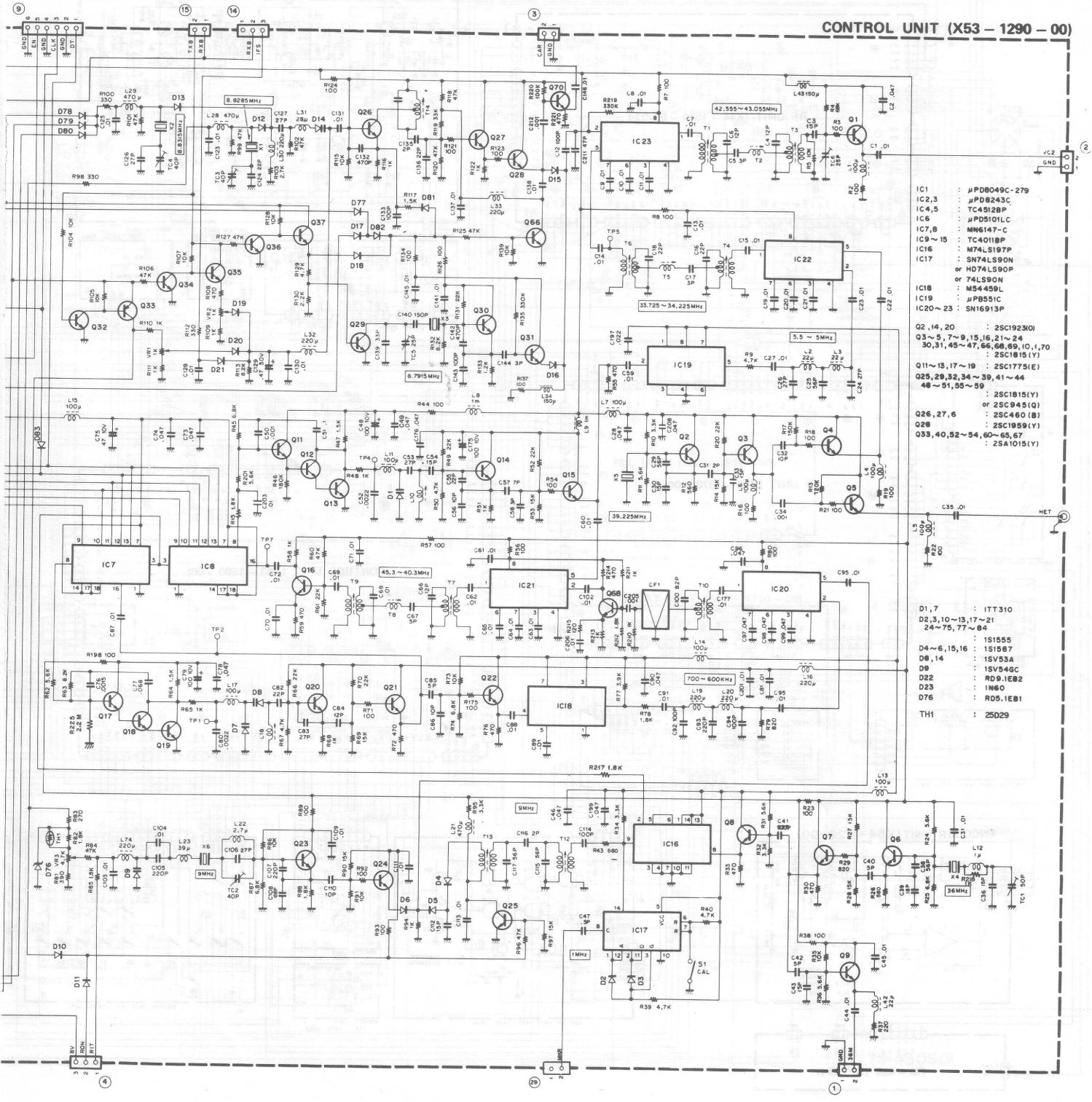

- IC1 : μPD8049C-279
 - IC2,3 : μPD8243C
 - IC4,5 : TC4512BP
 - IC6 : μPD5101C
 - IC7,8 : MN6147-C
 - IC9~15 : TC4011BP
 - IC16 : M74LS197P
 - IC17 : SN74LS90N
or HD74LS90P
or 74LS90N
 - IC18 : M54459L
 - IC19 : μPB551C
 - IC20~23 : SN16913P
-
- Q2,14,20 : 2SC1923(G)
 - Q3~5,7~9,15,16,21~24 : 2SC945(G)
 - 30,31,45~47,66,68,69,10,1,70 : 2SC1815(Y)
 - Q11~13,17~19 : 2SC1775(E)
 - Q25,29,32,34~39,41~44 : 2SC1815(Y)
 - 48~51,55~59 : 2SC1815(Y)
 - Q26,27,6 : 2SC945(G)
 - Q28 : 2SC460(B)
 - Q29 : 2SC1959(Y)
 - Q33,40,52~54,60~63,67 : 2SA1015(Y)
-
- D1,7 : 1TT310
 - D2,3,10~13,17~21 : 1S1555
 - 24~75,77~84 : 1S1587
 - D4~6,15,16 : 1S1587
 - D8,14 : 1SV53A
 - D11,14 : 1SV549C
 - D22 : RD9.1E82
 - D23 : 1M60
 - D76 : RD5.1E81
 - TH1 : 25D29

ORDERING SPARE PARTS

Spare parts may be ordered from any TRIO-KENWOOD dealer, or the factory service facility parts department. When ordering replacement or spare parts for your equipment, be sure to specify the following information: Model and serial number of the equipment. Schematic number of the part. Printed circuit board number on which the part is located. Part number and name, if known, and Quantity desired.

NOTE:

A full Service Manual is available as a separate publication. TRIO-KENWOOD Service Manuals typically contain: Specifications, expanded circuit descriptions, printed circuit board views, parts list, disassembly, Alignment, level chart, expanded schematics, block diagram, and other reference data.

Schematics show main signal paths, plus DC voltages and voltage lines are shown in a second colour. Accessory for the main unit are typically included.

SERVICE

Should it ever become necessary to return the equipment for repair, pack in its original boxes and packing, and include a full description of the problems involved. Also include your telephone number. You need not return accessory items unless directly related to the service problem.

You may return your radio for service to the Authorized Kenwood Dealer from whom you purchased it. A copy of the service report will be returned with the unit. Please do not send sub-assemblies or printed circuit boards. Send the complete unit, in its original boxes and packing. If you want verification of receipt, please supply a self-addressed card (or letter) and you will be informed of the date of receipt and estimated service time.

MASTER OSCILLATOR CALIBRATION

The built-in master oscillator can be calibrated using a WWV signal.

1. Remove the top and bottom cases.
2. Connect the second MKR terminal connector (29) on the Control unit and the RF unit M terminal with the supplied calibration cable.
1. Receive WWV at 10 MHz or 15 MHz (with an antenna connected.)
2. Place the Control CAL switch unit to ON.
3. The WWV signal and the marker signal may make two beat signals (high and low). Adjust the tuning control for zero-beat.
4. Adjust the F.ADJ trimmer TC1 adjacent to the CAL switch for zero-single beat.
This completes the calibration.
5. Turn the CAL switch OFF, Remove the calibration cable, and replace the cases.

SERVICE NOTE:

Dear OM, if you desire to correspond on a technical or operational problem, please make your note short, complete, and to the point. And PLEASE make it readable.

Please list: Model and serial number.

The question or problem you are having.

Please give sufficient detail to diagnose; other equipment in the station, meter readings and anything you feel might be useful in attempting diagnoses.

NOTE:

1. Record the data of purchase, serial number and dealer from whom purchased.
2. For your own information, retain a written record of any maintenance performed on the unit.
3. When claiming warranty service, please include a photocopy of the bill of sale, or other proof of purchase showing the date of sale.

LITHIUM BATTERY FOR MICROPROCESSOR BACK-UP

The TS-430S employs a lithium battery to back up stored memories.

The life of the battery is approximately five years.

If the display indicates 14.000.0 MHz, USB when turning the POWER ON and OFF, this may show the lithium battery needs replacement. This should be performed by an authorized TRIO-KENWOOD service facility — either your dealer or the factory.

ORDERING SPARE PARTS

Spare parts may be ordered from any TRIO-KENWOOD dealer in the factory service facility parts department. When ordering replacement or spare parts for your equipment, please specify the following information: Model & serial number of the equipment. Schematic number of the part. Printed circuit board number on which the part is located. Part number and name if known. Quantity desired.

NOTE

A full Service Manual is available as a separate publication. TRIO-KENWOOD Service Manuals (factory contact: Sales Office) expanded circuit diagrams, printed circuit board views, parts list, assembly alignment, level circuit, expanded schematic block diagram and other information. Schematics show main signal paths, plus DC voltages and voltage drops are shown in a second colour. Accessories for the model are typically indicated.

SERVICE

Should it ever become necessary to return the equipment for repair, pack in its original boxes and packing and include a full description of the problems involved. Also include your telephone number. You need not return the factory name unless directly related to the service work.

Model TS-430S

Serial No. _____

Date of Purchase _____

Dealer _____

A product of

TRIO-KENWOOD CORPORATION

17-5, 2-chome, shibuya, shibuya-ku Tokyo 150, Japan

TRIO-KENWOOD COMMUNICATIONS

1111 West Walnut Street, Compton, California, 90220, U.S.A.

TRIO-KENWOOD COMMUNICATIONS, GmbH

D-6374 Steinbach TS, Industriestrasse 8A, West Germany

TRIO-KENWOOD ELECTRONICS, N.V.

Leuvensesteenweg 504, B-1930 Zaventem, Belgium

TRIO-KENWOOD (AUSTRALIA) PTY. LTD.

4E Woodcock Place, Lane Cove N.S.W. 2066, Australia