

ADJUSTMENT

Adjustment Mode

• Overview

The transmission output, deviation, QT, DQT, and squelch can be adjusted by using the KPG-28D. There are three-point adjustment and one-point adjustment.

1. Three-point adjustment

(Three-point adjustment is carried out for each destination in the factory. After a desired frequency is written, each rating is checked.)

In the three-point adjustment, the inclination of adjustment is obtained based on the center (1CH), low (2CH), and high (3CH) frequencies in the frequency range in which the performance of the transceiver is guaranteed. The microprocessor calculates the adjustment value of the frequency in the band automatically according to the inclination.

Note: Three-point tuning for the KPG-28D (Adjustment of the center, lower limit, and upper limit frequencies (Three-point tuning))

The electronic volume can be tuned at the center, lower limit, and upper limit frequencies. (Three-point tuning)

1. Hold down [Alt] + [Shift] and press [F5] on the Main screen. The Password Window shown below will open.

| Password | |
|------------|----------------------|
| Password : | <input type="text"/> |

2. Enter the password. (3TUNING)
3. Press [Enter]. If the password is correct, the Test Mode Window opens.

2. One-point adjustment

When the three-point adjustment is carried out, the center (1CH) value is automatically set to magnification rate 1. Therefore, it is not required to perform one-point adjustment. (However, one-point adjustment is performed for squelch only.)

In the one-point adjustment, all frequencies in the band can be re-adjusted using the center (CH1) value as magnification rate 1. If a frequency is fine-adjusted, a desired frequency is set for 4CH or subsequent channel (4CH to 8CH), and the frequency is re-adjusted. In this case, all frequencies in the band are also re-adjusted.

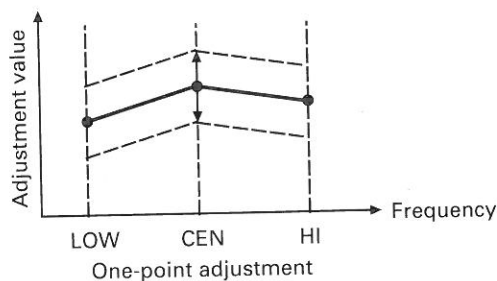
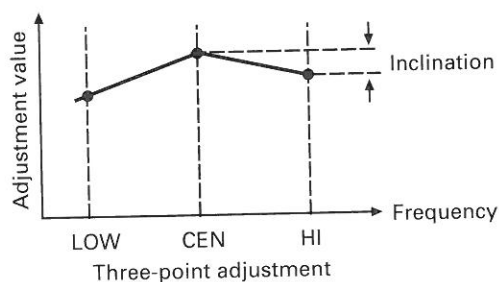

Note: One-point adjustment is used by dealers for fine adjustment. All the values are shifted automatically by moving one point (adjustment value).

Notes:

- 1) When the microprocessor is replaced, the main mode item of optional feature should be enabled using the KPG-28D. The main program appropriate for the version of the microprocessor should be written into the flash memory. In this case, re-adjustment is not required. (If the main item is not enabled, the main program is not written into the flash memory.)
- 2) If the flash memory is replaced, the main program should be written into the new flash memory. Then, re-adjustment should be carried out using the KPG-28D. In this case, set the frequency, then perform three-point adjustment. Perform one-point adjustment if necessary.

ADJUSTMENT

Required Test Equipment

1. Stabilized power supply

- 1) The supply voltage can be changed between 5V and 18V, and the current is 15A or more.
- 2) The standard voltage is 13.2V

2. DC ammeter

- 1) Class 1 ammeter (17 ranges and other features).
- 2) The full scale can be set to either 300mA or 10A.
- 3) A cable of less internal loss must be used.

3. Frequency counter (f. counter)

- 1) Frequency of up to 1GHz or so can be measured.
- 2) The sensitivity can be changed to 500MHz or below, and measurements are highly stable and accurate (0.2ppm or so).

4. Power meter

- 1) Measurable frequency : Up to 500MHz
- 2) Impedance : 50Ω, unbalanced
- 3) Measuring range : Full scale of 30W or so
- 4) A standard cable (5D2W 1m) must be used.

5. RF VTVM (RF V.M)

- 1) Measurable frequency : Up to 500MHz or so

6. Linear detector

- 1) Measurable frequency : Up to 500MHz
- 2) Characteristics are flat, and CN is 60dB or more.

7. Digital voltmeter

- 1) Voltage range : FS=18V or so
- 2) Input resistance : 1MΩ or more

8. Oscilloscope

- 1) Measuring range : DC to 30MHz
- 2) Provides highly accurate measurements for 5 to 25MHz.

9. AF voltmeter (AF VTVM)

- 1) Measurable frequency : 50Hz to 1MHz
- 2) Maximum sensitivity : 1mV or more

10. Spectrum analyzer

- 1) Measurable range : DC to 1GHz or more

11. Standard signal generator (SSG)

- 1) Maximum frequency : 500MHz or more
- 2) Output : -20dB/0.1μV to 120dB/1V
- 3) Output impedance : 50Ω

12. Tracking generator

- 1) Center frequency : 50kHz to 500MHz
- 2) Frequency deviation : ±35MHz
- 3) Output voltage : 100mV or more

13. Dummy load

- 1) 4Ω, 3W or more

- Use a non-conductive rod such as a Bakelite rod for adjustment (Especially of trimmers and coils).
- To protect the SSG, do not send out signals while adjusting the receiving unit.
- The indicated SSG output levels are for maximum output.

The set has been adjusted for the frequencies shown in the following table. When required, re-adjust them following the adjustment procedure to obtain the frequencies you want in actual operation.

| | E,E3,E4 | | E2 | |
|--------------|----------|----------|----------|----------|
| | TX (MHz) | RX (MHz) | TX (MHz) | RX (MHz) |
| CH1 (Center) | 460.000 | 460.050 | 420.000 | 420.050 |
| CH2 (Low) | 450.000 | 450.050 | 410.000 | 410.050 |
| CH3 (High) | 470.000 | 469.950 | 430.000 | 429.950 |

- The following test cable is recommended.

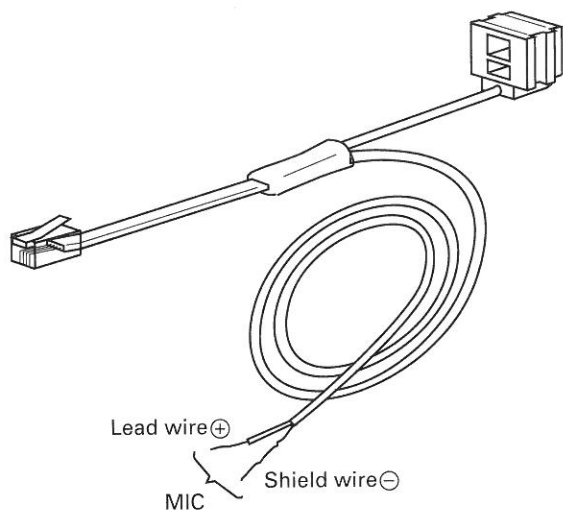

Tuning cable (E30-3217-05)

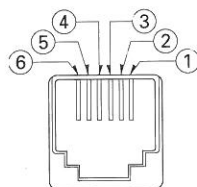

- ① SB
- ② PTTG
- ③ PTT
- ④ MICG
- ⑤ MIC
- ⑥ HOOK

MIC connector
(Front view)

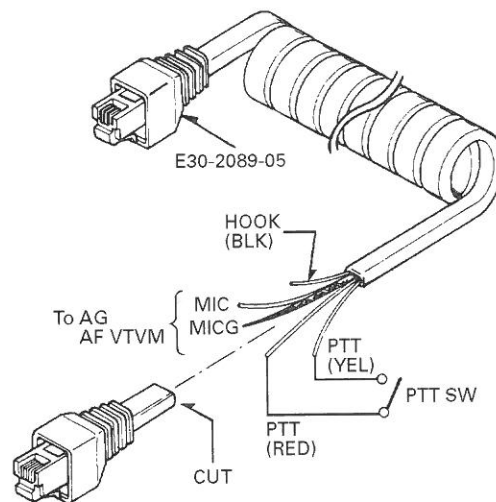

Test cable for microphone input

ADJUSTMENT

Adjustment Point

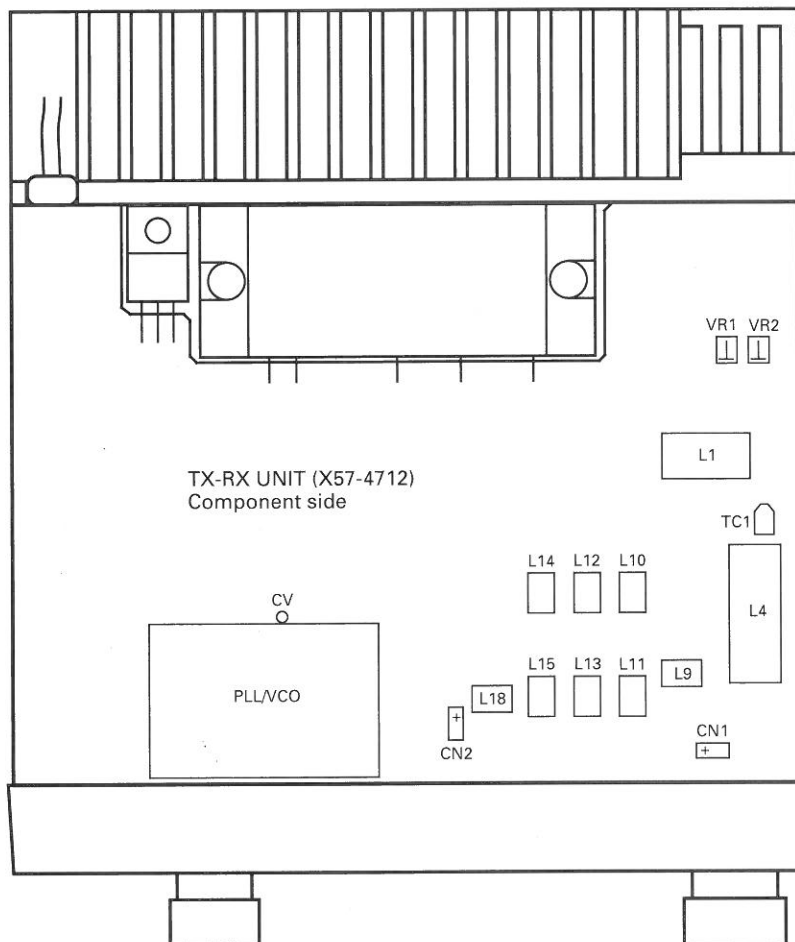

- L1,4 : BPF
- L9,10,12,14 : IFT & MCF (Wide)
- L11,13,15 : IFT & MCF (Narrow)
- L18 : Discriminator
- TC1 : BPF
- VR1 : Maximum power
- VR2 : Protection

How to Use the Jig

Parts No. : E37-0660-05

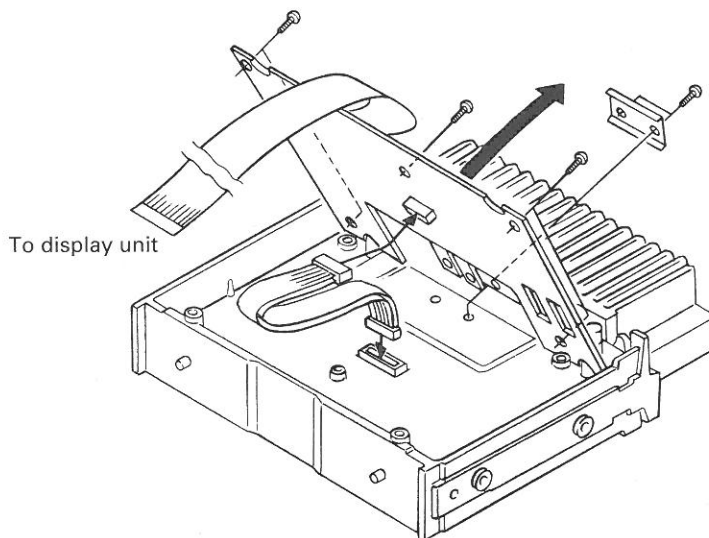
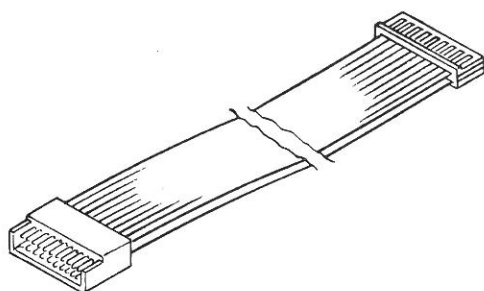

ADJUSTMENT

Common Section Adjustment

| Item | Condition | Measurement | | | Adjustment | | | Specifications/Remarks |
|-----------------------|---|------------------------------|------------|----------|---|-------|--------|---|
| | | Test-equipment | Unit | Terminal | Unit | Parts | Method | |
| 1. Setting | <p>• Receiver section</p> <p>The indicated SSG output level are for maximum output.</p> <p>Whenever there is no modulation designation, standard modulation (MOD : 1kHz, (Wide) DEV : ±3.0kHz E,E2, ±2.4kHz E3,E4, (Narrow) DEV : ±1.5kHz) is indicated.</p> | <p>• Transmitter section</p> | | | <p>Description of function keys</p> <p>PC : IBM-PC</p> <p>←/→ : Move the cursor with the keys.</p> <p>Spacebar : Switch between TX and RX.</p> <p>Enter key : Set a value and go to the next step.</p> | | | |
| 2. PLL lock voltage | <p>1) CH : Channel with lowest RX FREQ' (f_{RL})</p> <p>2) CH : Channel with highest RX FREQ' (f_{RH})</p> <p>3) CH : Channel with lowest TX FREQ' (f_{TL}) PTT : ON</p> <p>4) CH : Channel with highest TX FREQ' (f_{TH}) PTT : ON</p> | DVM Power meter | TX-RX | CV | | | Check | 2.5V or more |
| | | | | | | | | 7.5V or less |
| | | | | | | | | 2.5V or more |
| | | | | | | | | 7.5V or less |
| 3. Transmit frequency | 1) CH : Channel with TX center FREQ' (f _{TM}) PTT : ON | Power meter f.counter | Rear panel | ANT | | | Check | f ± 0.69kHz E,E3,E4 f ± 0.63kHz E2 |

Receiver Section Adjustment

| Item | Condition | Measurement | | | Adjustment | | | Specifications/Remarks |
|--------|--|---|-------------------------|----------------|------------|--------------|--|--|
| | | Test-equipment | Unit | Terminal | Unit | Parts | Method | |
| 1. BPF | 1) CH : Channel with RX center FREQ' (f _{RM}) SSG output : -30dBm | Tracking generator Spectrum analyzer | Rear panel TX-RX | ANT CN1 | TX-RX | L1,L4 TC1 | Align to set the waveform of spectrum analyzer as light. | <p>450 460 470 E,E3,E4</p> <p>410 420 430 E2</p> <p>Gain max.</p> <p>2dB</p> |

ADJUSTMENT

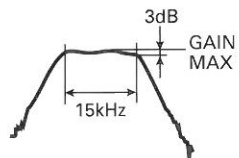
| Item | Condition | Measurement | | | Adjustment | | | Specifications/Remarks |
|------------------|--|---|------------|-------------------|------------|------------|---|---|
| | | Test-equipment | Unit | Terminal | Unit | Parts | Method | |
| 2. IFT & MCF | 1) CH : Channel with RX center FREQ' (f _{RM}) (Wide) Tracking generator output : -20dBm | Tracking generator Spectrum analyzer | TX-RX | CN1 | TX-RX | L9 | Gain MAX. |  |
| | 2) CH : Channel with RX center FREQ' (f _{RM}) (Narrow) Tracking generator output : -20dBm | | | CN2 | | L10 L12 | Align to set the waveform of spectrum analyzer as right. Note : When replacing L14 or L15, turn the core two turns mechanically. | |
| 3. Discriminator | 1) Channel with RX center FREQ' (f _{RM}) (Wide) SSG output : -53dBm AF : 1.4V/4Ω | SSG AF VTVM Oscilloscope | Rear panel | ANT EXT.SP | TX-RX | L18 | AF output MAX. | |
| 4. Distortion | 1) CH : Channel with RX center FREQ' (f _{RM}) (Wide) SSG output : -53dBm AF : 1.4V/4Ω | SSG Distortion meter AF VTVM Oscilloscope | Rear panel | ANT EXT.SP | | | Check | 3% or less |
| | 2) CH : Channel with RX center FREQ' (f _{RM}) (Narrow) | | | | | | | |
| 5. Sensitivity | 1) CH : Channel with lowest RX FREQ' (f _{RL}) (Wide) SSG output : -117dBm AF : 0.45V/4Ω | | | | | | Check | SINAD 12dB or more. |
| | 2) CH : Channel with highest RX FREQ' (f _{RH}) (Wide) | | | | | | | |
| | 3) CH : Channel with lowest RX FREQ' (f _{RL}) (Narrow) | | | | | | | |
| | 4) CH : Channel with highest RX FREQ' (f _{RH}) (Narrow) | | | | | | | |
| 6. Squelch | 1) CH : Channel with RX center FREQ' (f _{RM}) (Wide) SSG output : Value when 3dB is subtracted from the sensitivity value of 12dB SINAD. AF : 0.45V/4Ω | SSG Distortion meter AF VTVM Oscilloscope Ammeter | Rear panel | ANT EXT.SP | PC | ←/→ | Set to the point at which squelch just close. | |
| | 2) SSG output : 12dB SINAD | | | | | | | |
| | 3) SSG output : OFF | | | | | | | |
| | 4) CH : Channel with RX center FREQ' (f _{RM}) (Narrow) SSG output : Value when 3dB is subtracted from the sensitivity value of 12dB SINAD. | | | | | | | |
| | 5) SSG output : 12dB SINAD | | | | | | | |
| | 6) SSG output : OFF | | | | | | | |
| | | | | | | | Check | Squelch should open. Squelch should close. |
| | | | | | PC | ←/→ | Set to the point at which squelch just close. | |
| | | | | | | | Check | Squelch should open. Squelch should close. |

ADJUSTMENT

Transmitter Section Adjustment

| Item | Condition | Measurement | | | Adjustment | | | Specifications/Remarks |
|--|---|--|-------------|----------|------------|-------|---|---|
| | | Test-equipment | Unit | Terminal | Unit | Parts | Method | |
| 1. Power output | 1) Maximum power CH : Channel with highest TX FREQ' (f _{TH}) PTT : ON | Power meter | Rear panel | ANT | TX-RX | VR1 | 26.5W E,E2 11.0W E3 7.0W E4 | ±0.5W |
| | 2) CH : Channel with TX center FREQ' (f _{TM}) PTT : ON | Ammeter | | | PC | ←/→ | 25.0W E,E2 10.0W E3 6.0W E4 | ±0.5W 7.5A or less E,E2 5.0A or less E3 3.5A or less E4 |
| | 3) CH : Channel with lowest TX FREQ' (f _{TL}) PTT : ON | | | | | | 25.0W E,E2 10.0W E3 6.0W E4 | ±0.5W |
| | 4) Low power CH : Channel with highest TX FREQ' (f _{TH}) PTT : ON | | | | | | 5.0W E,E2 1.0W E3,E4 | ±0.5W E,E2 ±0.3W E3,E4 |
| | 5) CH : Channel with TX center FREQ' (f _{TM}) PTT : ON | | | | | | | |
| | 6) CH : Channel with lowest TX FREQ' (f _{TL}) PTT : ON | | | | | | | |
| <ul style="list-style-type: none"> To adjust the power, set VR1 to the value listed above in 1-1), and adjust it accurately (to the operating power) using an IBM-PC. 10W or higher : Operating power +1.0W Lower than 10W : Operating power +0.3 to 0.5W 1W : Set VR1 to the minimum power. Adjust the power in the same way if the low power is mainly used. | | | | | | | | |
| 2. Maximum deviation (Wide) | 1) CH : Channel with highest TX FREQ' (f _{TH}) AG : 1kHz/50mV Deviation meter filter HPF : OFF LPF : 15kHz De-emphasis : OFF PTT : ON | Power meter Deviation meter Oscilloscope | Rear panel | ANT | PC | ←/→ | ±4.1kHz E,E2 ±3.3kHz E3,E4 (According to the larger +, -) | ±0.1kHz Oscilloscope waveform is not abnormal. |
| | 2) CH : Channel with TX center FREQ' (f _{TM}) PTT : ON | AF VTVM | Front panel | MIC | | | | |
| | 3) CH : Channel with lowest TX FREQ' (f _{TL}) | AG | | | | | | |
| 3. Maximum deviation (Narrow) | 1) CH : Channel with highest TX FREQ' (f _{TH}) AG : 1kHz/50mV Deviation meter filter HPF : OFF LPF : 15kHz De-emphasis : OFF PTT : ON | | | | | | ±2.05kHz (According to the larger +, -) | ±0.05kHz Oscilloscope waveform is not abnormal. |
| | 2) CH : Channel with TX center FREQ' (f _{TM}) PTT : ON | | | | | | | |
| | 3) CH : Channel with lowest TX FREQ' (f _{TL}) | | | | | | | |

ADJUSTMENT

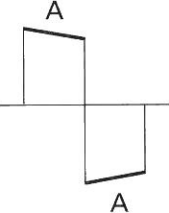
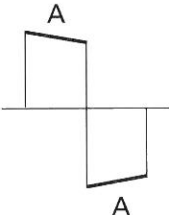
| Item | Condition | Measurement | | | Adjustment | | | Specifications/Remarks |
|-------------------------|---|--|-------------|----------|------------|-------|---|--|
| | | Test-equipment | Unit | Terminal | Unit | Parts | Method | |
| 4. MIC sensitivity | 1) CH : Channel with TX center FREQ' (f _{TM}) (Wide) AG : 1kHz/5mV PTT : ON | Power meter Deviation meter Oscilloscope | Rear panel | ANT | | | Check | ±2.2~3.6kHz E,E2 ±1.7~2.8kHz E3,E4 |
| | 2) CH : Channel with TX center FREQ' (f _{TM}) (Narrow) AG : 1kHz/5mV PTT : ON | AF VTVM AG | Front panel | MIC | | | | ±1.1~1.8kHz |
| 5. DTMF deviation | 1) CH : Channel with TX center FREQ' (f _{TM}) / D (Wide) PTT : ON | | | | PC | ←/→ | ±3.0kHz E,E2 ±2.4kHz E3,E4 (According to the larger +, -) | ±0.1kHz |
| 6. 5-TONE deviation | 1) CH : Channel with TX center FREQ' (f _{TM}) / 1kHz (Wide) Deviation meter filter HPF : 300Hz LPF : 3kHz De-emphasis : OFF PTT : ON | | | | | | ±3.0kHz E,E2 ±2.4kHz E3,E4 (According to the larger +, -) | ±0.1kHz |
| 7. DQT balance (Wide) | 1) CH : Channel with highest TX FREQ' (f _{TH}) / 023N Deviation meter filter HPF : OFF LPF : 3kHz De-emphasis : OFF PTT : ON | | | | | | | Flat the A parts.  |
| | 2) CH : Channel with TX center FREQ' (f _{TM}) / 023N PTT : ON | | | | | | | |
| | 3) CH : Channel with lowest TX FREQ' (f _{TL}) / 023N PTT : ON | | | | | | | |
| 8. DQT balance (Narrow) | 1) CH : Channel with highest TX FREQ' (f _{TH}) / 023N Deviation meter filter HPF : OFF LPF : 3kHz De-emphasis : OFF PTT : ON | | | | | | | Flat the A parts.  |
| | 2) CH : Channel with TX center FREQ' (f _{TM}) / 023N PTT : ON | | | | | | | |
| | 3) CH : Channel with lowest TX FREQ' (f _{TL}) / 023N PTT : ON | | | | | | | |
| 9. DQT deviation (Wide) | 1) CH : Channel with highest TX FREQ' (f _{TH}) / 023N Deviation meter filter HPF : OFF LPF : 3kHz De-emphasis : OFF PTT : ON | | | | | | 0.75kHz E,E2 0.60kHz E3,E4 | ±0.05kHz |
| | 2) CH : Channel with TX center FREQ' (f _{TM}) / 023N PTT : ON | | | | | | | |
| | 3) CH : Channel with lowest TX FREQ' (f _{TL}) / 023N PTT : ON | | | | | | | |

ADJUSTMENT

| Item | Condition | Measurement | | | Adjustment | | | Specifications/Remarks |
|----------------------------|---|--|-------------|----------|------------|-------|---|--|
| | | Test-equipment | Unit | Terminal | Unit | Parts | Method | |
| 10. DQT deviation (Narrow) | 1) CH : Channel with highest TX FREQ' (f _{TH}) / 023N Deviation meter filter HPF : OFF LPF : 3kHz De-emphasis : OFF PTT : ON | Power meter Deviation meter Oscilloscope | Rear panel | ANT | PC | ←/→ | 0.35kHz | ±0.05kHz |
| | 2) CH : Channel with TX center FREQ' (f _{TM}) / 023N PTT : ON | AF VTVM AG | Front panel | MIC | | | | |
| | 3) CH : Channel with lowest TX FREQ' (f _{TL}) / 023N PTT : ON | | | | | | | |
| 11. QT deviation (Wide) | 1) CH : Channel with highest TX FREQ' (f _{TH}) / 151.4Hz Deviation meter filter HPF : 50Hz LPF : 3kHz De-emphasis : OFF PTT : ON | | | | | | 0.75kHz E,E2 0.60kHz E3,E4 | ±0.05kHz |
| | 2) CH : Channel with TX center FREQ' (f _{TM}) / 151.4Hz PTT : ON | | | | | | | |
| | 3) CH : Channel with lowest TX FREQ' (f _{TL}) / 151.4Hz PTT : ON | | | | | | | |
| 12. QT deviation (Narrow) | 1) CH : Channel with highest TX FREQ' (f _{TH}) / 151.4Hz Deviation meter filter HPF : 50Hz LPF : 3kHz De-emphasis : OFF PTT : ON | | | | | | 0.35kHz | ±0.05kHz |
| | 2) CH : Channel with TX center FREQ' (f _{TM}) / 151.4Hz PTT : ON | | | | | | | |
| | 3) CH : Channel with lowest TX FREQ' (f _{TL}) / 151.4Hz PTT : ON | | | | | | | |
| 13. Protection | 1) CH : Channel with highest TX FREQ' (f _{TH}) ANT : Open Space key 1 push : TX | Ammeter | Front panel | MIC | TX-RX | VR2 | Current min. | 7.5A or less E,E2 4.0A or less E3 |
| | | | | | | | Check | 3.5A or less E4 |