

ICOM

HF MARINE

INSTRUCTION MANUAL

HF MARINE TRANSCEIVER  
**IC-M800**

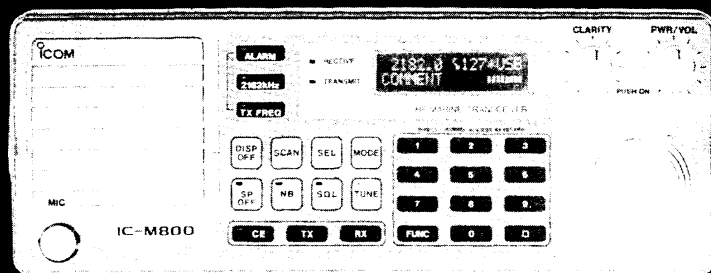

Icom Inc.

## FOREWORD

Thank you for choosing the **IC-M800 HF MARINE TRANSCEIVER**. Icom uses the most advanced, state-of-the-art engineering concepts and the latest technology.

To fully appreciate the capabilities of your new **IC-M800**, please read this instruction manual thoroughly. For further information, please feel free to contact your nearest Icom Dealer or Service Center.

## EXPLICIT DEFINITIONS

The following explicit definitions apply to this instruction manual.

WORD	DEFINITION
<b>WARNING</b>	Personal injury, fire hazard or electric shock may occur.
<b>CAUTION</b>	Equipment damage may occur.
<b>NOTE</b>	If disregarded, inconvenience only. No personal injury, risk of fire or electric shock.

## IMPORTANT SAFETY PRECAUTIONS

**READ THIS INSTRUCTION MANUAL** carefully and completely before attempting operation.

**SAVE THIS INSTRUCTION MANUAL** - This instruction manual contains important safety and operating instructions for the IC-M800.

**WARNING** - Mount the transceiver securely with bolts and nuts. If the transceiver is mounted without bolts and nuts, personal injury or transceiver damage could occur due to wave shock, vibrations, etc.

**NEVER** connect the transceiver to an AC outlet or more than a 16 V DC power source.

**AVOID** using the transceiver in temperatures below  $-30^{\circ}\text{C}$  ( $-22^{\circ}\text{F}$ ) or over  $+60^{\circ}\text{C}$  ( $+140^{\circ}\text{F}$ ). The transceiver may not function properly in extreme temperatures.

**AVOID** using the transceiver in excessively dusty environments.

**AVOID** placing the transceiver in direct sunlight.

**BE CAREFUL!** The heatsink may become hot when operating the transceiver continuously for long periods.

During maritime mobile operations, **DO NOT** operate the transceiver without running the boat's engine.

## UNPACKING

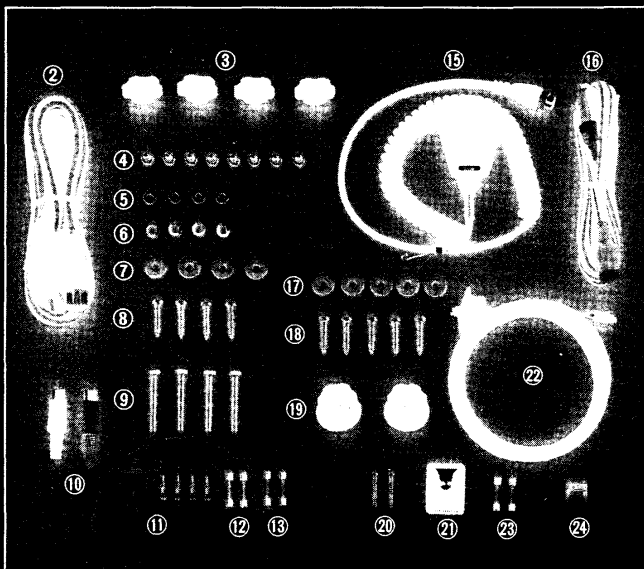

\* Mounting brackets for the transceiver and remote controller and the cable clamp are not shown in the picture above.

Accessories for the transceiver	Qty.
① Mounting bracket *	1
② DC power cable (OPC-077)	1
③ Mounting knobs	4
④ Nuts	8
⑤ Flat washers (for mounting knobs)	4
⑥ Spring washers (use together with nuts)	4
⑦ Flat washers	4
⑧ Self tapping screws	4
⑨ Bolts	4
⑩ DIN plugs	4
⑪ 4-pin connector (use when connecting a tuner)	1 set
⑫ Spare fuses (30 A for DC power cable)	2
⑬ Spare fuses (5 A for the internal circuitry)	2

Accessories for the remote controller	Qty.
⑭ Mounting bracket *	1
⑮ Microphone (EM-48)	1
⑯ DC power cable (OPC-089A)	1
⑰ Flat washers	4
⑱ Self-tapping screws	4
⑲ Mounting knobs (assembled rubber washer)	2
⑳ Self tapping screws (for microphone hanger)	2
㉑ Microphone hanger	1
㉒ Interface cable (OPC-172A)	1
㉓ Spare fuses (3 A for DC power cable)	2
㉔ Cable stopper (for interface cable)	1
㉕ Cable clamp* (for DC power cable)	1

---

# TABLE OF CONTENTS

---

<b>FOREWORD</b> .....	<b>i</b>	<b>9. TRANSMITTING</b> .....	<b>16</b>
<b>EXPLICIT DEFINITIONS</b> .....	<b>i</b>	- Transmitting	
<b>IMPORTANT SAFETY PRECAUTIONS</b> .....	<b>i</b>	<b>10. WRITING A FREQUENCY</b> .....	<b>17</b>
<b>UNPACKING</b> .....	<b>i</b>	- Writing a frequency	
<b>TABLE OF CONTENTS</b> .....	<b>ii</b>	- Clearing memory information	
<b>1. FEATURES</b> .....	<b>1</b>	- Writing a comment	
<b>2. OPERATING RULES AND GUIDELINES</b> .....	<b>2</b>	<b>11. OPERATING THE SCAN</b> .....	<b>18</b>
<b>3. PANEL DESCRIPTION</b> .....	<b>3</b>	- Scanning	
- Remote controller front panel		- Scanning with external equipment	
- Remote controller rear panel		- Selecting a scan speed	
- Transceiver front panel		<b>12. ALARM SIGNAL</b> .....	<b>19</b>
- Transceiver rear panel		- Transmitting an alarm signal	
- Function display		- Testing an alarm signal	
<b>4. INSTALLATION</b> .....	<b>7~10</b>	- Distress call procedures	
- Mounting the remote controller		<b>13. SETTING THE DISPLAY CONTRAST</b> .....	<b>20</b>
- Mounting the transceiver		- Changing the display contrast	
- Remote controller connections		- Turning the display backlight ON/OFF	
- Transceiver connections		<b>14. MULTI-CONTROLLER OPERATION</b> <b>(OPTIONAL)</b> .....	<b>21</b>
- Typical installation		- Connecting remote controllers	
- Ground connections		- Priority of the clarity control	
- Antenna connections		- Operation note	
- Power source		<b>15. INTERCOM OPERATION (OPTIONAL)</b> .....	<b>22</b>
<b>5. EXTERNAL EQUIPMENT</b> <b>CONNECTIONS</b> .....	<b>11</b>	- Operating the intercom function	
- AT-120 HF AUTOMATIC ANTENNA TUNER		<b>16. INTERNAL PRE-SETTINGS</b> .....	<b>23</b>
- MN-100/MN-100L ANTENNA MATCHERS		<b>17. MAINTENANCE</b> .....	<b>24</b>
- AFSK terminal unit		- Replacing a fuse	
- CW key		- Installing an optional FL-32A filter	
- ACC socket information		- Resetting the microprocessor	
<b>6. SELECTING A CHANNEL</b> .....	<b>13</b>	- Cleaning	
- Selecting a user-programmable memory channel		<b>18. TROUBLESHOOTING</b> .....	<b>25</b>
- Selecting an ITU channel		<b>19. CHANNEL CHART</b> .....	<b>26</b>
- Selecting 2182 kHz		- User-programmable memory channel .....	<b>26</b>
<b>7. SETTING A FREQUENCY</b> .....	<b>14</b>	- ITU channel list (SSB) .....	<b>26</b>
- Setting a frequency		- ITU channel list (FSK) .....	<b>26</b>
- Changing the frequency in 100 Hz steps		<b>20. SPECIFICATIONS</b> .....	<b>27</b>
<b>8. RECEIVING</b> .....	<b>15</b>	<b>21. OPTIONS</b> .....	<b>28</b>
- Receiving			

### INDIVIDUAL, SPLASH-RESISTANT REMOTE CONTROLLER

The separate controller is completely splash resistant and is only 286(W) × 111(H) × 62(D) mm\*, meaning it can be mounted practically anywhere. Up to 4 controllers (optional) can be connected to the IC-M800, controlling the transceiver anywhere. In addition, 4 controllers can also act as an intercom system.

\* 11.3(W) × 4.4(H) × 2.4(D) in

### STATE-OF-THE-ART OPTICAL FIBER CABLE

Optical fiber technology is another feature that makes the IC-M800 special. The optical fiber cable is approx. only 5 mm in diameter and can be easily installed beneath carpets or out of sight beneath window ledges. Tough, flexible and reliable, the cable will not corrode or pick up noise from other electrical systems on your vessel.

### 160 CONVENIENT MEMORY CHANNELS

Up to 160 user-programmable memory channels are available for your operating convenience. Each memory channel can store transmit and receive frequencies, operating mode and 7-digit alphabetical descriptions for your note.

### 848 ITU CHANNELS

The IC-M800 is designed with 704 pre-programmed ITU duplex channels (242 channels for SSB and 462 channels for FSK). The ITU duplex channels can be used as reverse frequencies between transmit and receive for coastal station operation. In addition, 144 ITU simplex channels (72 channels for SSB and 72 channels for FSK) are equipped with the transceiver.

### CONTINUOUS COVERAGE RECEIVER

The IC-M800 continuously covers all short wave frequencies from 0.5 to 30 MHz in 100 Hz steps including all marine frequencies. You can listen to international shortwave broadcasts, weather channels and news broadcasts.

### CHANNEL ACCESS VERSATILITY

Memory channel selection is quick and convenient via the main dial or 10-keyboard. The main dial and 10-keyboard can also be used for frequency changing.

### MEMORY SCAN

Memory scan is available for signal searching. Scan a specified channel with a variable scanning time of 1~10 sec. per channel.

### FSK CAPABILITY

The IC-M800 is designed for FSK operation such as RTTY or SITOR with the following features:

- Rapid Transmit/Receive switching time with Icom's DDS (Direct Digital Synthesizer) System.
- Optional 500 Hz/−6 dB filter installation capability for better selectivity in CW and FSK modes.
- An ACC socket for connecting an external terminal unit.

### ACC SOCKETS

The IC-M800 has 2 ACC sockets on the rear panel. They are input/output terminals and are used for connecting external equipment such as a linear amplifier, SITOR terminal unit, etc. The socket also has a scan control terminal for externally controlling IC-M800 scanning.

### S/RF INDICATOR

The indicator shows relative signal strength while receiving and relative output power while transmitting. This is useful for checking transmit modulation.

### 5 W AUDIO OUTPUT POWER

The IC-M800 emits 5 W powerful audio output power. You'll have no problem being heard when one remote controller (optional) is installed on the deck as a function of the intercom.

### EXCELLENT FREQUENCY STABILITY

All oscillator circuits in the IC-M800 are controlled with only one high-stability crystal unit. A total frequency stability of ±15 Hz is therefore obtained.

### OPTIONAL AUTOMATIC ANTENNA TUNER

The optional AT-120 HF AUTOMATIC ANTENNA TUNER can be used with a variety of vessels, even smaller boats that cannot use a long wire antenna element.

No adjustment is necessary. Just push the [TUNE] switch on the controller; the AT-120 adjusts the SWR to a matched condition in any frequency on an HF marine band.

## ■ Operating rules and guidelines

Before transmitting, monitor the channel you wish to use to avoid interrupting transmissions already in progress.

### (1) Call procedures

Calls must be properly identified and time limits must be respected.

- 1) Give your call sign each time you call another vessel or a coastal station. If you have no call sign, identify the station by giving the vessel name and the name of the licensee.
- 2) Give your call sign at the end of each transmission that lasts more than 3 minutes.
- 3) You must break and give your call sign at least once every 15 minutes during long ship-to-shore calls.
- 4) Keep your unanswered calls short (less than 30 seconds) and do not repeat a call for 2 minutes.
- 5) Unnecessary transmissions are not allowed.

### (2) Priorities

- 1) Read all the rules and regulations pertaining to priorities and keep an up-to-date copy handy. Safety and distress calls take priority over all others.
- 2) False or fraudulent distress signals are prohibited and punishable by law.

### (3) Privacy

- 1) Information overheard but not intended for you cannot lawfully be used in any way.
- 2) Indecent or profane language is prohibited.

### (4) Logs

- 1) All distress, emergency and safety calls must be recorded in complete detail. Log data activity is usually recorded in 24 hour time. Universal Time (formerly UTC) is frequently used.
- 2) Adjustments, repairs, channel frequency changes and authorized modifications affecting electrical operation of the equipment must be kept in the maintenance log and entries signed by the authorized licensed technician performing or supervising the work.

### (5) Radio licenses

#### 1) Ship Station License

When your craft is equipped with an HF marine transceiver such as the IC-M800 you must have a current radio station license before using the equipment. It is unlawful to operate a ship station which is not licensed.

Inquire through your dealer or the appropriate government agency for a Ship Radiotelephone License application. Your government-issued license states the call sign which is your craft's identification for radio purposes.

#### 2) Operator's License

A Restricted Radiotelephone Operator Permit is the license most often held by small vessel radio operators when a radio is not required for safety purposes. You can usually obtain this permit by mail.

The Restricted Radiotelephone Operator Permit must be posted or kept with the operator. Only a licensed radio operator may operate a transceiver.

However, non-licensed individuals may talk over a transceiver if a licensed operator starts, supervises, and ends the call, and makes the necessary log entries.

A current copy of the applicable government rules and regulations is usually required to be kept.

# 3 PANEL DESCRIPTION

## Remote controller front panel

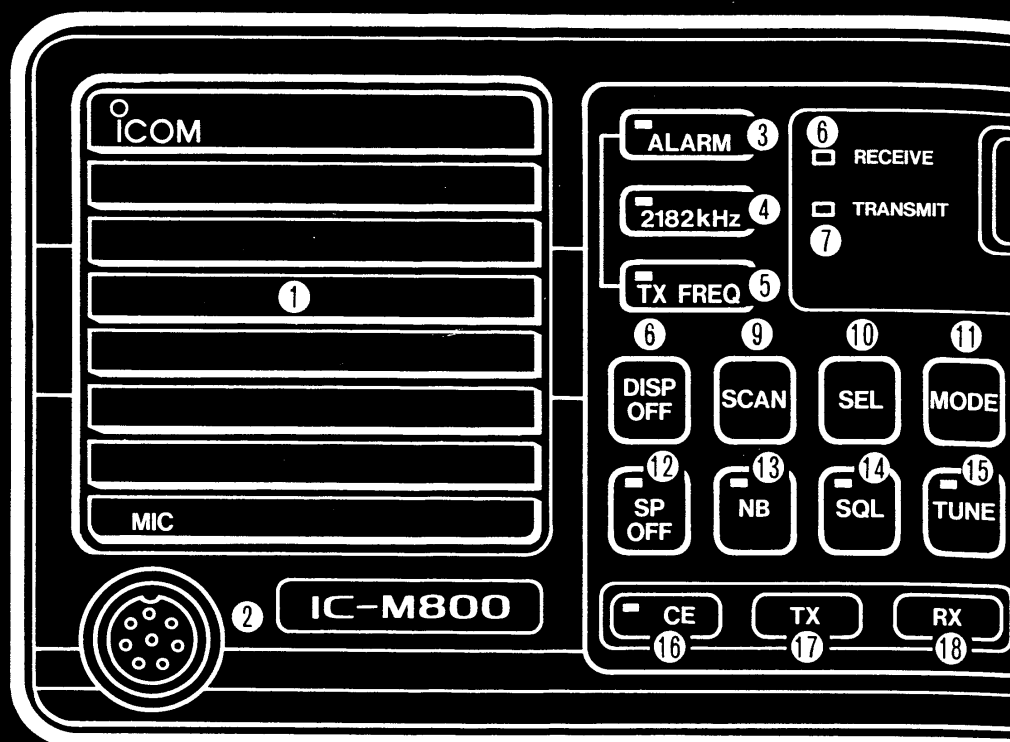

### 1 INTERNAL SPEAKER

Operates when the transceiver is receiving or the intercom is operating.

### 2 MIC CONNECTOR

Connects the supplied microphone or an optional HS-50 HANDSET here.

### 3 ALARM SWITCH [ALARM] (p. 19)

- Turns ON and OFF the alarm function.
- Transmits alarm signals when pushing this switch together with [TX FREQ].

### 4 2182 kHz SWITCH [2182kHz] (p. 19)

Selects the 2182 kHz emergency and distress call frequency.

### 5 TRANSMIT FREQUENCY CHECK SWITCH [TX FREQ] (p. 16)

Switches the displayed receive frequency to the transmit frequency to check whether the frequency is busy or not.

### 6 RECEIVE INDICATOR [RECEIVE] (p. 15)

Lights when the transceiver is receiving and the squelch opens.

### 7 TRANSMIT INDICATOR [TRANSMIT] (p. 17)

Lights when the transceiver is transmitting.

### 8 DISPLAY LIGHT SWITCH [DISP OFF] (p. 20)

Turns OFF and ON the function display and switch indicator lights.

### 9 SCAN SWITCH [SCAN] (p. 18)

Starts and stops the scan.

### 10 SELECT CHANNEL SWITCH [SEL] (p. 18)

Selects the channels you want to scan.

### 11 MODE SWITCH [MODE] (pgs. 15, 16)

Selects the desired operating mode.

### 12 SPEAKER SWITCH [SP OFF] (p. 15)

Turns OFF and ON receive sounds from the internal speaker

### 13 NOISE BLANKER SWITCH [NB] (p. 15)

Turns ON and OFF the noise blanker function.

### 14 SQUELCH SWITCH [SQL] (p. 15)

Closes and opens the squelch function.

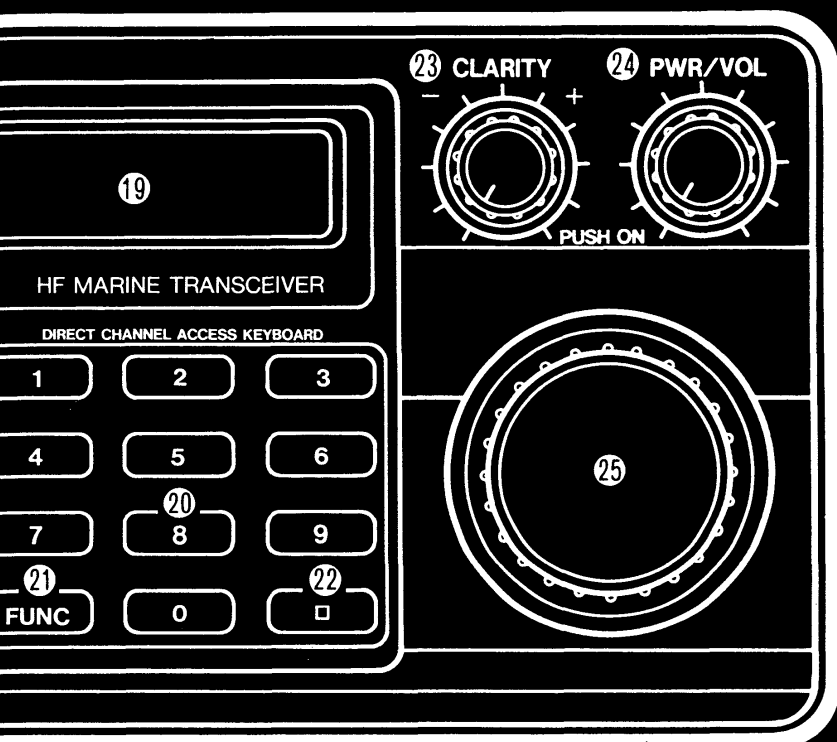

**15 ANTENNA TUNER SWITCH [TUNE] (p. 16)**

Starts the tuning of the AT-120 HF AUTOMATIC ANTENNA TUNER (optional).

**16 CLEAR ENTRY SWITCH [CE] (p. 14)**

- Clears an entry and retrieves the previous key input.
- Sets the transceiver to change the display frequency at 100 Hz steps with the main dial when the switch lights.

**17 TRANSMIT FREQUENCY ENTER SWITCH [TX] (pgs. 13, 14)**

- Recalls a memory channel with the keyboard.
- Used when the desired transmit frequency is stored into a memory channel.

**18 RECEIVE FREQUENCY SWITCH [RX] (p. 13)**

- Recalls a memory channel with the keyboard.
- Used when the desired receive frequency is stored into a memory channel.

**19 FUNCTION DISPLAY (p. 6)**

Indicates current operating frequency, channel, mode and additional information.

**20 10-KEYBOARD (pgs. 13, 14)**

Used to input a frequency or memory channel number.

**21 FUNCTION SWITCH [FUNC]**

Activates secondary functions.

**22 CLARITY PRIORITY SWITCH [□] (p. 21)**

Sets the controller priority for controlling [CLARITY].

**23 CLARITY CONTROL [CLARITY] (p. 15)**

Shifts only the receive frequency by  $\pm 150$  Hz.

**24 POWER SWITCH AND VOLUME CONTROL [PWR/VOL]**

- Turns ON and OFF the transceiver power.
- Varies the audio output level from the internal speaker.

**25 MAIN DIAL (p. 13)**

- Changes the display frequency in 100 Hz steps when the CE indicator lights.
- Changes the memory channel when the CE indicator does not light.

### 3 PANEL DESCRIPTION

#### ■ Remote controller rear panel

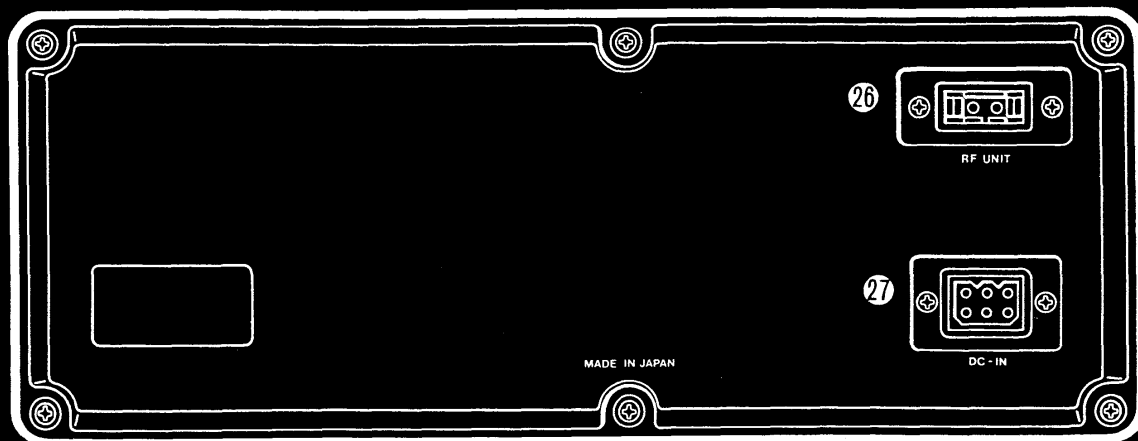

#### 26 CONTROL CABLE CONNECTOR [RF UNIT] (p. 8)

Connect the control cable between the transceiver and controller here.

#### 27 DC POWER CONNECTOR [DC-IN] (p. 8)

Connect the supplied DC power cable from this connector to an external 12 V DC power source.

#### ■ Transceiver front panel

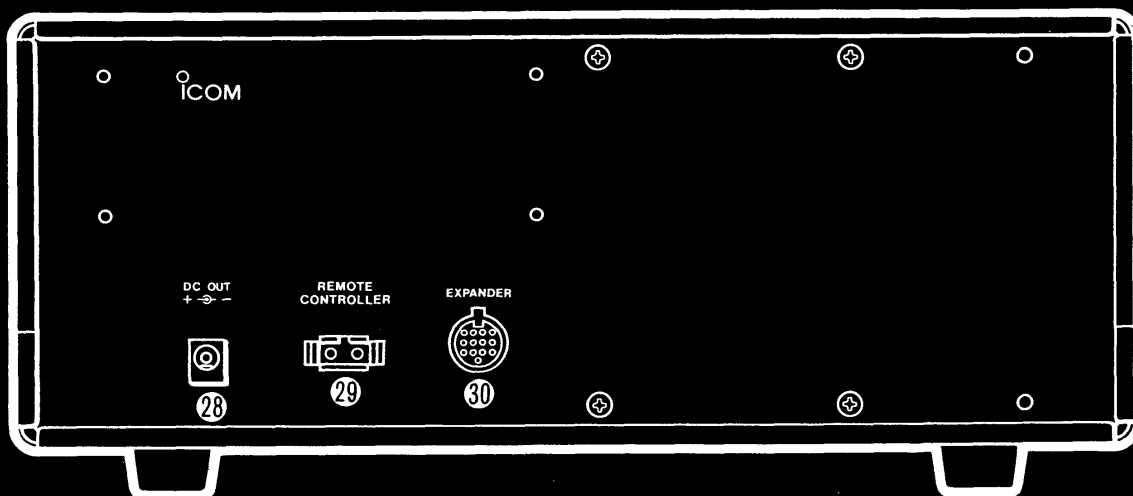

#### 28 DC OUTPUT JACK [DC OUT] (p. 8)

Outputs 12 V DC (max. 1 A). The jack can be used when connecting external equipment to the transceiver.

#### 29 CONTROL CABLE CONNECTOR [REMOTE CONTROLLER] (p. 8)

Connect the control cable between the transceiver and controller here.

#### 30 EXPANDER UNIT SOCKET [EXPANDER] (p. 21)

Connect the plug from the EX-804 EXPANDER UNIT (optional) here.



## ■ Transceiver rear panel

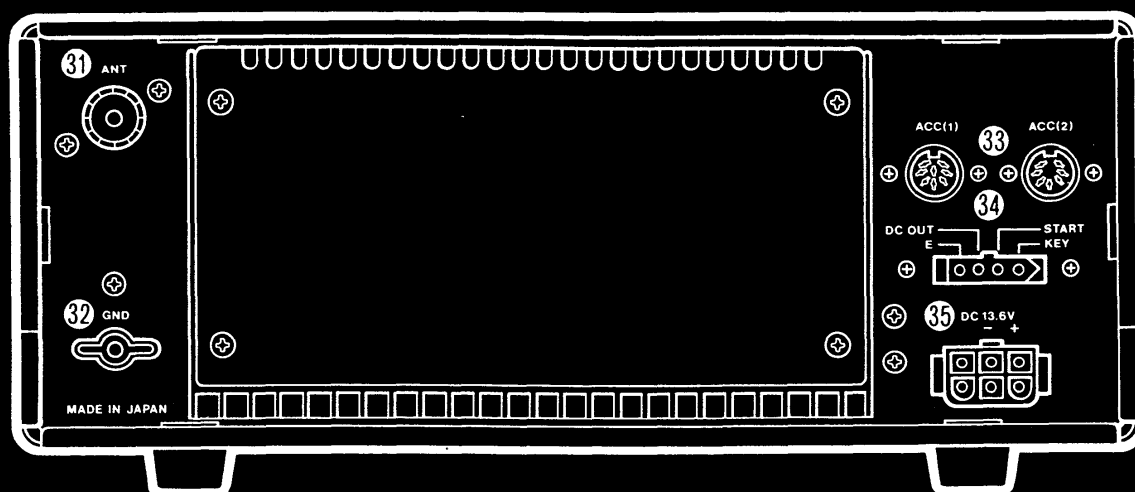

### 31 ANTENNA CONNECTOR [ANT] (p. 10)

Connect an antenna cable here. A PL-259 plug must be used.

### 32 GROUND TERMINAL [GND] (p. 10)

To prevent electrical shocks, interference from other electronic equipment, and other problems, be sure to ground the transceiver to a good earth point.

### 33 ACCESSORY SOCKETS [ACC(1)/ACC(2)] (p. 12)

Input and output signals for external equipment connections.

### 34 ANTENNA TUNER CONNECTOR (p. 11)

Connect the control cable of the AT-120 HF AUTOMATIC ANTENNA TUNER (optional) here.

### 35 DC POWER CONNECTOR [13.6V DC] (pgs. 8, 10)

Connects the supplied DC power cable from this connector to an external 12 V DC power source.

## ■ Function display



### A FREQUENCY INDICATOR (p. 14)

Displays the operating frequency.

### E MEMORY CHANNEL INDICATOR (p. 13)

Indicates the channel numbers.

### C SCAN CHANNEL INDICATOR (p. 18)

Indicates that the displayed channel is programmed as a scan channel.

### D MODE INDICATOR

Indicates the operating mode.

### E FUNCTION INDICATOR

Indicates the [FUNC] key has been pushed.

### F S/Rf INDICATOR

Indicates the relative signal strength when receiving and the relative output power when transmitting.

### G SCAN INDICATOR (p. 18)

Indicates while scanning.

### H COMMENT INDICATOR (p. 17)

- Shows the comment of each channel.
- A frequency is displayed in this area when an ITU channel is selected.

### ■ Mounting the remote controller

The remote controller may be installed at the operator's station. The universal bracket supplied with your controller allows "overhead" or "dashboard" mounting. Read the following installation instructions carefully.

- 1) Select a location for the controller that allows access to the front panel easily for steering safety.
- 2) DO NOT select areas subject to extreme heat, cold, vibrations, or direct sunlight.
- 3) Install the mounting bracket as shown in the diagram below so the controller is adequately supported, thus protecting it from wave shock and vibrations.
- 4) Mount the controller to the bracket and adjust the viewing angle, then tighten the mounting knobs.

### ■ Mounting the transceiver

The transceiver may be installed in a closet, storage room or underneath the dashboard or table using the supplied mounting hardware. Read the following installation instructions carefully.

- 1) Select a location for the transceiver that allows good ventilation and a dry environment.
- 2) AVOID mounting the transceiver in a suspended way since it is heavy.
- 3) DO NOT select areas subject to extreme heat, cold, vibrations, near electro-magnetic sources or in direct sunlight.
- 4) Install the bracket and mount the transceiver as shown in the diagrams below.

#### ● Dashboard mounting

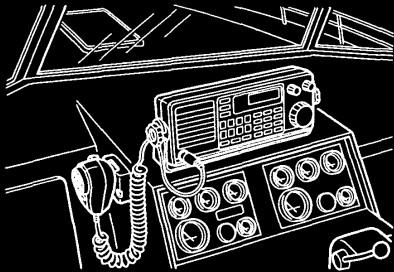

#### ● Overhead mounting

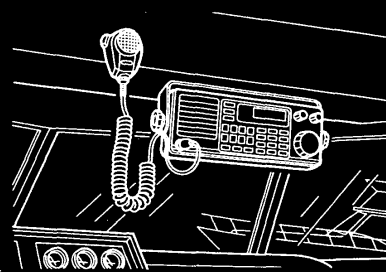

#### ● Remote controller bracket installation

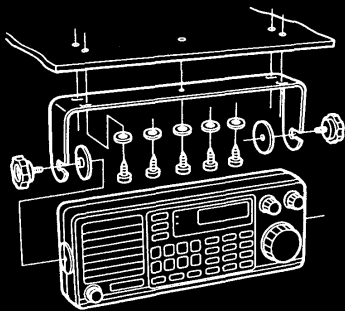

#### ● Transceiver bracket installation

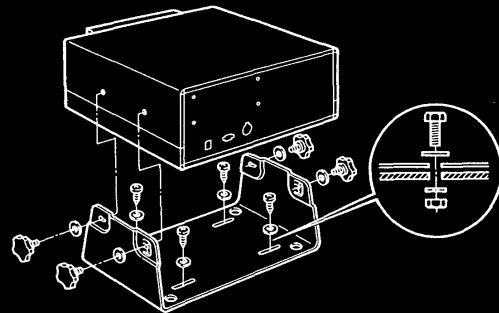

#### ● Mic cord hook attachment

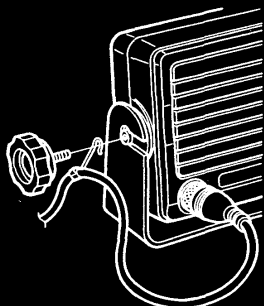

#### ● Variable viewing angle

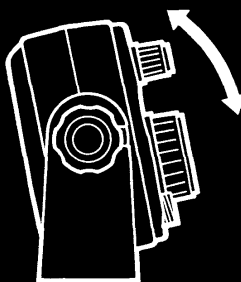

#### ● Microphone hanger installation

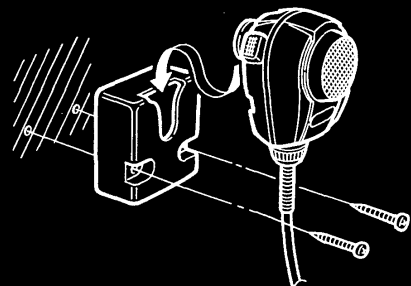

## Remote controller connections

The remote controller needs 2 kinds of cable connections:

- Supplied interface cable (OPC-172A)
- Supplied DC power cable (OPC-089A)

### (1) Interface cable

The cable is connected between the controller and the transceiver. See the diagram below.

Since this is an optical fiber cable,

- DO NOT force or bend the cable too strongly.
- DO NOT cut or try to lengthen the cable.

### (2) DC power cable

Connect the cable to a 12 V DC power source (at least 1 A) directly. See the diagram below and p.10 for details.

## Transceiver connections

The transceiver needs at least 3 kinds of cable connections:

- Supplied DC power cable (OPC-077)
- Ground
- Antenna coaxial cable

### (1) DC power cable

Connect the cable to a 12 V DC power source (at least 30 A) directly. See the figure below and p.10 for details.

### (2) Ground

The transceiver **MUST** have an adequate ground connection. See p. 10 for details.

### (3) Antenna coaxial cable

Connect a 50  $\Omega$  coaxial cable with a PL-259 connector. See p. 10 for details.

#### Connecting the DC power cable

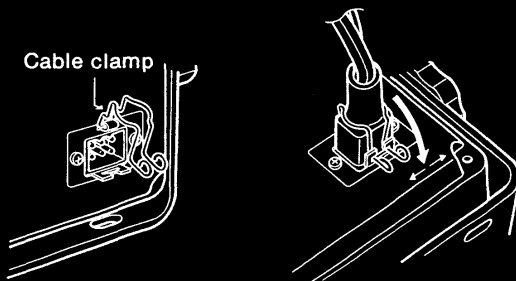

#### IMPORTANT:

The cable clamp must be securely hooked over the DC power cable to prevent it being removed by vibrations, wave shocks, etc.

#### Cable interconnections

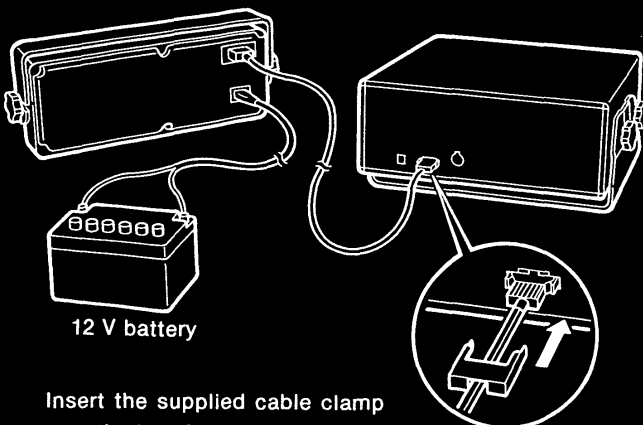

Insert the supplied cable clamp over the interface cable connector as shown at right.

#### Attaching the interface cable

- 1) Unscrew 2 screws on the controller.
- 2) Remove the metal plate.
- 3) Pass the interface cable through the plate.
- 4) Attach the cable and plate with screws.

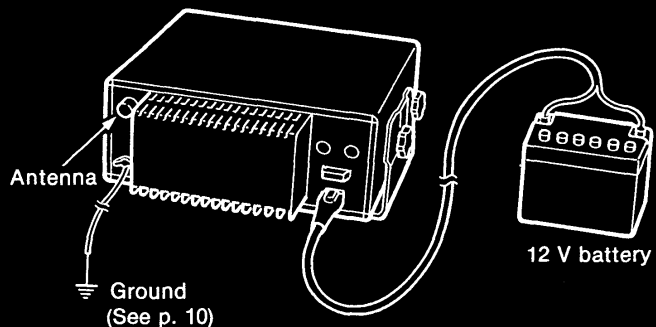
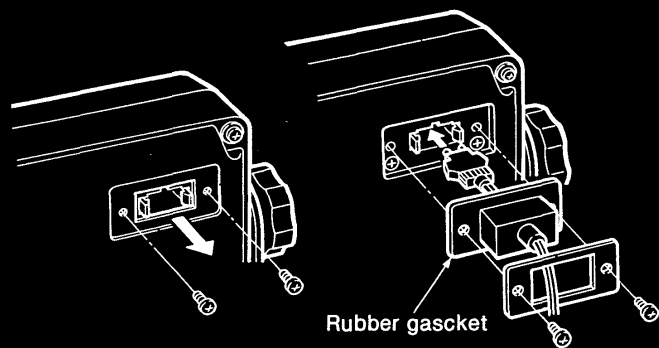

## 4 INSTALLATION

### ■ Typical installation

The following diagrams show a typical installation of the IC-M800 with the AT-120. The installation consists of the following six major parts:

- IC-M800 REMOTE CONTROLLER
- IC-M800 TRANSCEIVER (main body)
- AT-120 HF AUTOMATIC ANTENNA TUNER (See p. 11)
- 12 V DC power source (See p. 10)
- Antenna (See p. 10)
- Ground (See p. 10)

#### (1) IC-M800 remote controller installation

See pgs. 7 and 8 for installation and connections.

#### (2) IC-M800 transceiver installation (main body)

See pgs. 7 and 8 for installation and connections.

#### (3) AT-120 (optional)

The AT-120 ensures there is a matched condition in the antenna at all times. See p. 11 for installation and connection procedures.

#### (4) 12 V DC power source

The IC-M800 requires regulated DC power; 12 V and at least 30 A. See p. 10 for the power cable connections.

#### (5) Antenna

The AT-120 requires an antenna wire (element) at least 25 feet (7.6 m) long for covering all HF marine bands. See p. 11 for more information.

#### (6) Ground

Grounding is an important connection. See p. 10 for the transceiver and tuner ground system.

#### ● Typical installation with the AT-120 antenna tuner

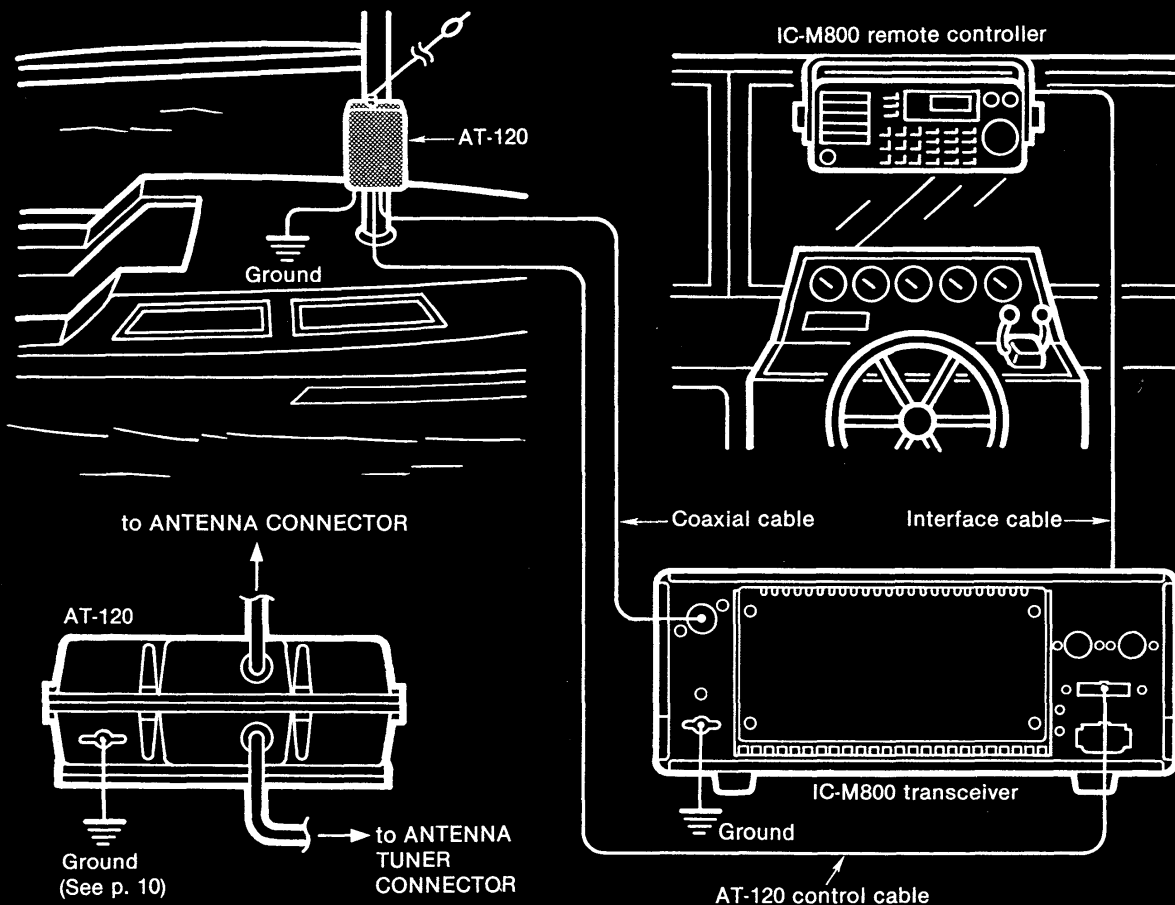

## ■ Ground connections

The transceiver and antenna tuner **MUST** have an adequate ground connection. Otherwise the overall efficiency of the transceiver and antenna tuner installation will be degraded. Electrical shocks and interference from other electric equipment could also occur.

For best results, use the heaviest gauge wire or strap available and make the connection as short as possible.

For wooden or fiber-glass boats, make the ground connection to the engine block or other large metal objects, or use a copper ground plate, etc. See the diagram at right for an example of grounding.

### ● Example ground system

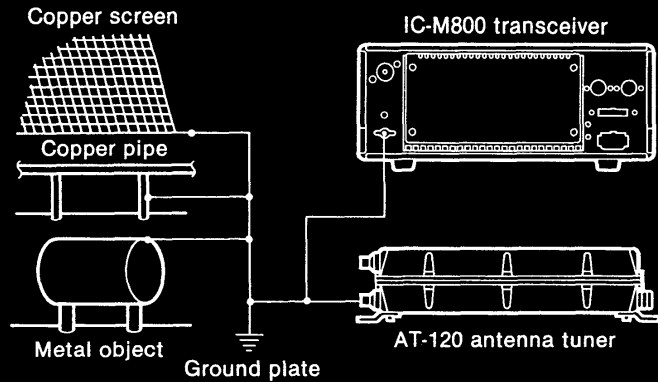

## ■ Antenna connections

Most stations operate with a whip or long wire (insulated back stay) antenna. However, these antennas cannot be connected directly to the transceiver since their antenna impedance is not matched with the transceiver antenna connector. Keep the following procedures in mind:

- Whip or long wire antennas require an optional AT-120 HF AUTOMATIC ANTENNA TUNER, MN-100 or MN-100L ANTENNA MATCHER. (See p. 11)
- A 50 Ω impedance antenna is required. (Ask your dealer for details.)

### ● PL-259 connector attachment

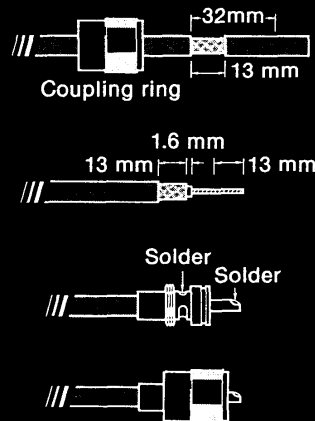

- 1) Slide the coupling ring over the coaxial cable.
- 2) Strip the cable as shown in the figure, and soft solder the center conductor.
- 3) Slide the connector body onto the cable and solder.
- 4) Screw the coupling ring onto the connector body.

(1 mm ≅ 1/32 in)

## ■ Power source

The IC-M800 requires regulated DC power: 12 V and at least 30 A. There are 3 ways to activate power:

- Connect the power cable directly to the 12 V, 30 A battery in the boat.
- Connect an optional Icom PS-60 AC POWER SUPPLY to an AC outlet.
- Connect an optional Icom PS-66 DC-DC CONVERTER to a 19~32 V DC power source.

**CAUTION:** The supplied DC power cable **MUST** be used to provide power to the transceiver. **AVOID** exceeding the 10-foot (3 m) length of the DC power cable. If it is necessary to make a run over 10 feet, use #6 or a similar cable as the supplied DC power cable up to a maximum of 20 feet (6 m).

### ● DC power cable connection

**NOTE:** Use terminals for the cable connections.

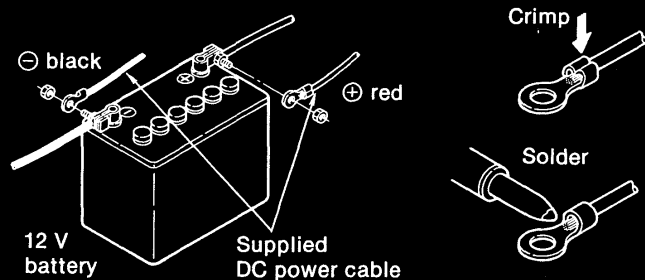

## ■ AT-120 HF AUTOMATIC ANTENNA TUNER

### ● AT-120 cable connections

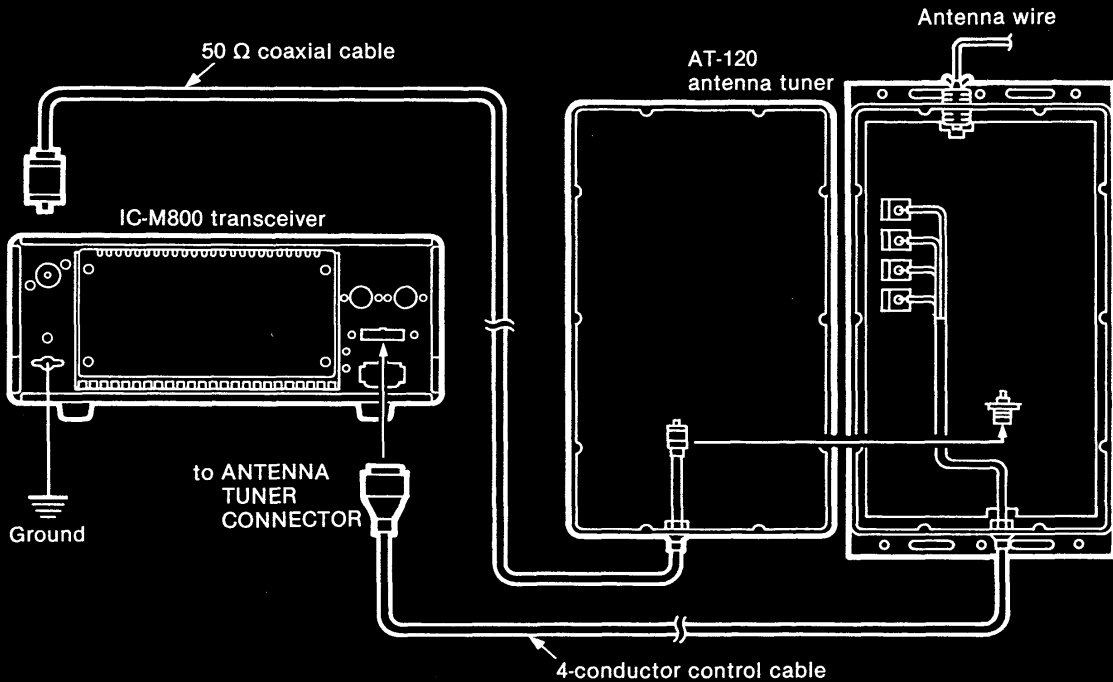

### ● Control cable connections

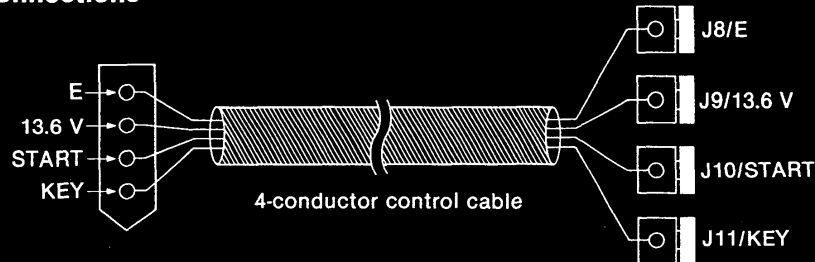

## ■ MN-100/MN-100L ANTENNA MATCHERS

### ● Connecting a wire with wire clamps

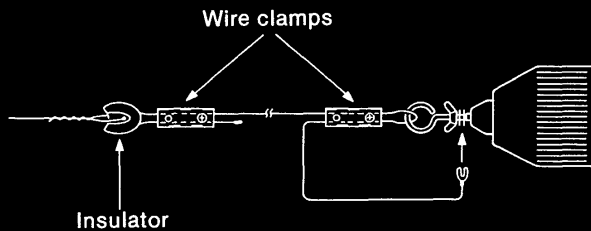

### ● Using the MN-100 with a long wire antenna

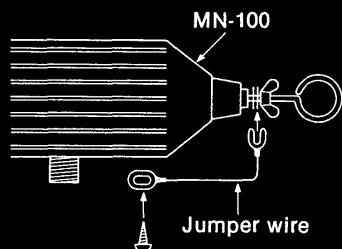

### ● Typical installation

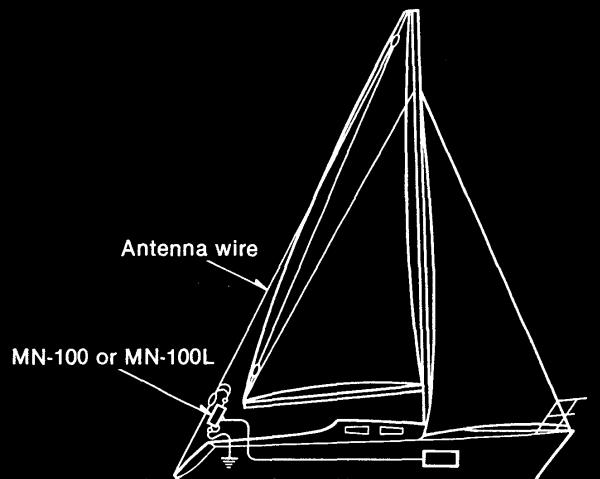

## ■ AFSK terminal unit

### ● AFSK terminal unit connections

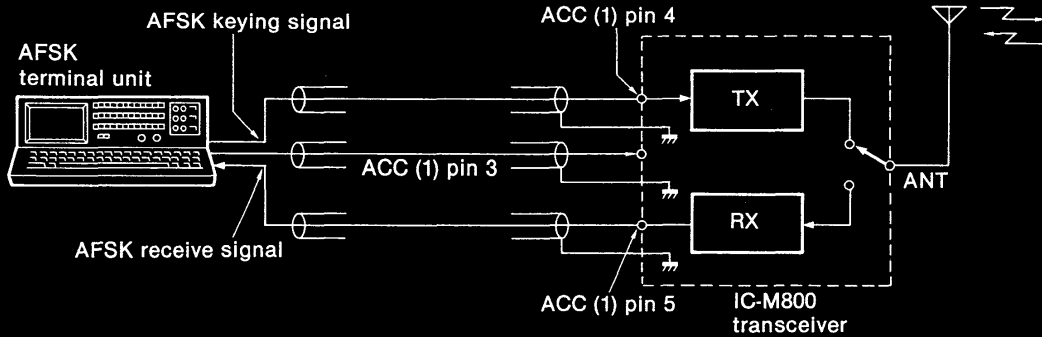

## ■ CW key

### ● CW key connections

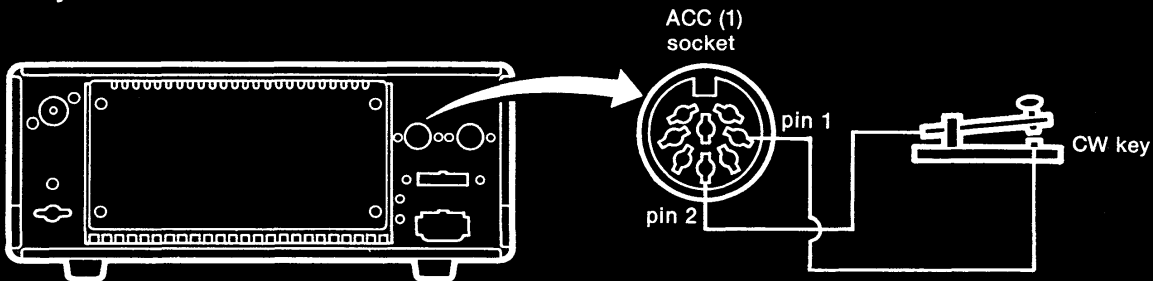

The CW key must be operated in transmit mode. Push the PTT switch during operation or make a ground connection at ACC (1) pin 3.

## ■ ACC socket information

### ACC (1)

PIN NO.	PIN NAME	DESCRIPTION	SPECIFICATION
1	CWK	Connect a CW key for CW operation.	Less than 0.6 V when keying down.
2	GND	Connected to the chassis ground.	
3	SEND	When grounded, transmits.	Mic input is muted. Pin 4 (MOD) accepts a modulation input.
4	MOD	Modulation input for external equipment.	Imp. : 10 kΩ Input: Max. 10 mV
5	AF	Fixed AF output regardless of [VOL].	100~300 mV rms with 4.7 kΩ load.
6	SCAN	Input/output for scan control from external equipment.	Less than 0.6 V: Scanning. More than 4 V: Scan stops.
7	13.6V	13.6 V output.	Max. 1 A.
8	ALC	ALC voltage input.	-3~0 V.

### ACC (2)

PIN NO.	PIN NAME	DESCRIPTION	SPECIFICATION
1	8V	8 V output.	Max. 10 mA.
2	GND	Connected to the chassis ground.	
3	SEND	Same as ACC(1) pin 3.	
4	BAND	Band voltage output.	
5	ALC	Same as ACC(1) pin 8.	
6	RL	Goes to ground when transmitting.	Max. 50 V DC, 0.5 A.
7	13.6V	Same as ACC(1) pin 7.	

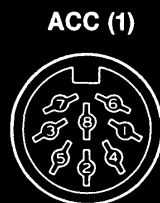

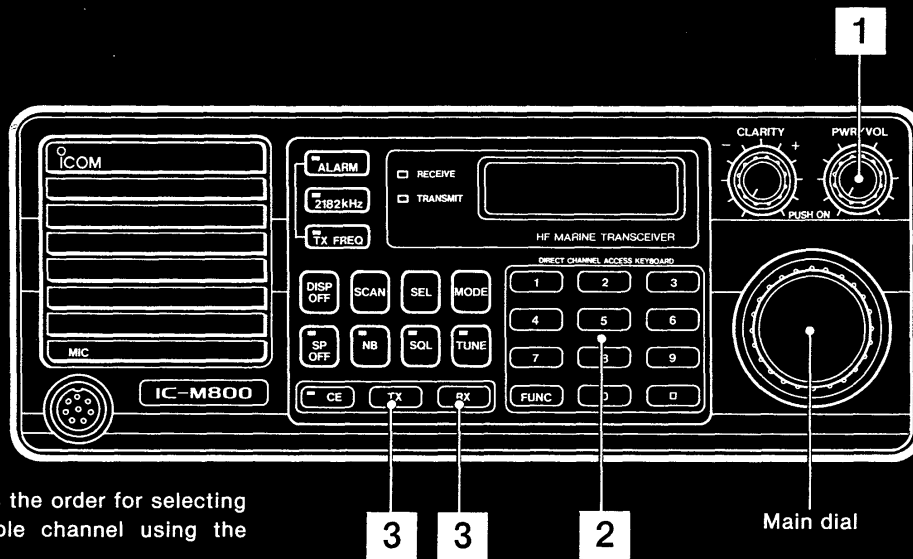

The diagram shows the order for selecting a user-programmable channel using the 10-keyboard.

## ■ Selecting 2182 kHz

- 1 Push [2182kHz] to select the 2182 kHz emergency and distress call frequency quickly.
- 2 To return to the previous frequency, push [2182kHz] again.

## ■ Selecting a user-programmable memory channel

The IC-M800 has 160 user-programmable memory channels. There are 2 ways to select the desired memory channel:

- Using the main dial.
- Using the 10-keyboard.

### (1) Using the main dial

- 1 Push [PWR/VOL] to turn ON power.
- 2 Rotate the main dial to select the desired channel.
  - 160 user-programmable memory channels are available. (See p. 17 for writing a frequency.)

### (2) Using the 10-keyboard

- 1 Push [PWR/VOL] to turn ON power.
- 2 Select your desired memory channel using the 10-keyboard.

**NOTE:** The 10-keyboard does not function when the CE indicator lights. To turn OFF the indicator, push [CE].

- 3 Push [TX] or [RX] to enter the memory channel number.
  - The desired memory channel appears.

## ■ Selecting an ITU channel

The IC-M800 has 242 ITU duplex channels for SSB, 462 ITU duplex channels for FSK, 72 ITU simplex channels for SSB and 72 ITU simplex channels for FSK modes.

- 1 Push [PWR/VOL] to turn ON power.
- 2 Push [MODE] to select the desired operating mode.
  - To change the operating mode from SSB to FSK modes or vice versa in ITU channel, access a channel between 1~160, push [MODE] to select the operating mode, then select the desired ITU channel as in the below procedures.
- 2 Select your desired memory channel using the 10-keyboard.
  - An ITU channel is automatically selected when channel 401 or above is entered.
  - ITU simplex channels cannot be selected using the 10-keyboard. See the box below for selection.
- 4 Push [RX] to enter the memory channel number.
  - The desired ITU channel appears.
  - To select the reverse frequency for coastal stations, push [TX] instead of [RX].
- 5 Rotate the main dial to change a channel.
  - For quick channel changing, push [FUNC] then rotate the main dial.

### Selecting an ITU simplex channel.

- 1) Select an ITU duplex channel using the 10-keyboard.
- 2) Rotate the main dial until the desired ITU simplex channel appears.



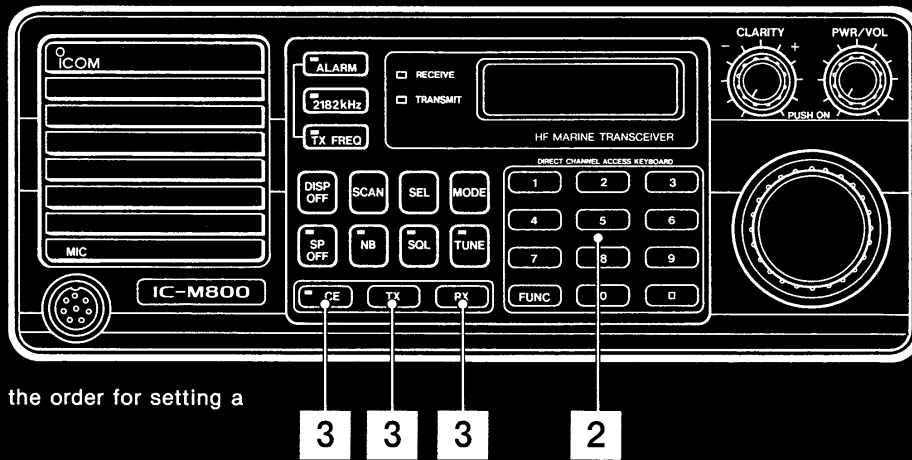

The diagram shows the order for setting a frequency.

## ■ Setting a frequency

**NOTE:** The displayed frequency clears and a new frequency is stored in the displayed memory channel when operating on a memory channel between 1~160 and continuing with the following procedures.

ITU channels are fixed and can not be changed or cleared.

- 1** Push [CE].
  - The CE indicator lights.
- 2** Enter the desired frequency in kHz using the 10-keyboard.
- 2** Push [RX] or [TX] to enter the receive or transmit frequency respectively.
  - The CE indicator disappears.

**Example:** Selecting 2182 kHz.

- 1) Push [CE].
- 2) Push [2] [1] [8] [2] [0].
- 3) Push [RX] or [TX] to enter the receive or transmit frequency respectively.

## ■ Changing the frequency in 100 Hz steps

- 1** Push [CE].
  - The CE indicator lights.
- 2** Rotate the main dial.
  - The displayed frequency (receive frequency) changes in 100 Hz steps.
- 3** To clear this function, push [CE] again.
  - The CE indicator disappears.

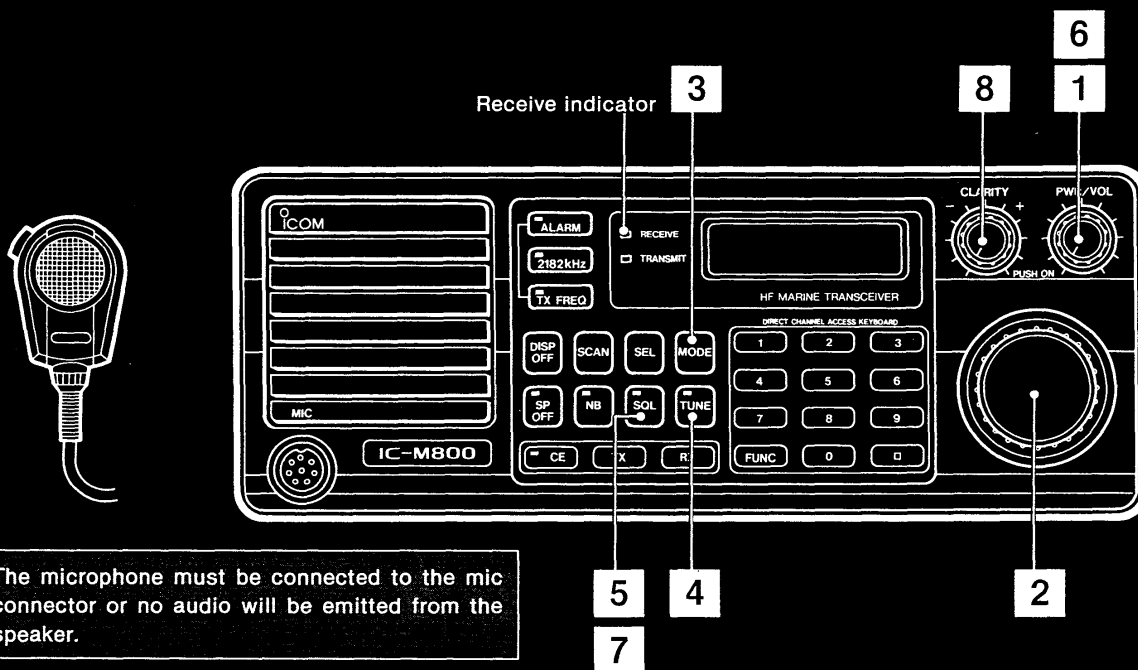

**NOTE:** The microphone must be connected to the mic connector or no audio will be emitted from the speaker.

## Receiving

- 1 Push [PWR/VOL] to turn ON power.
- 2 Select the desired operating channel or frequency.
  - For selecting a channel, see p. 13.
  - For setting a frequency, see p. 14.
- 2 Push [MODE] to select the desired operating mode.
- 4 Push [TUNE] when an optional AT-120 HF AUTOMATIC ANTENNA TUNER is connected.
  - Push [TUNE] each time you have changed the operating channel.
  - The AT-120 automatically tunes the connected antenna wire (or element).
  - The TUNE indicator lights while the AT-120 is tuning.
  - The [TUNE] switch only functions when the AT-120 is connected to the IC-M800.
- 5 Push [SQL] to turn OFF the squelch function when the SQL indicator lights.
- 6 Adjust [PWR/VOL] to the desired listening level.
- 7 Push [SQL] to turn ON the squelch function when necessary.
  - The SQL indicator lights.
  - The function mutes audio output from the speaker when receiving no signal.
- 8 Adjust [CLARITY] to allow clear reception for an off frequency.
  - To have better receiver selectivity in CW and FSK modes, install an optional FL-32A filter. See p. 24 for the installation procedures.

### Use the noise blanker function

When receiving signals in LSB, USB or CW mode and the signals include pulse-type noise such as from engine ignitions, use the noise blanker function.

Push [NB] to turn ON the noise blanker function and reduce the noise level.

### Use the squelch function

This function quiets speaker noise when no voice signals are received on the desired channel in AM or SSB mode. The squelch opens only when voice signals are received. This function allows you quiet waiting periods.

When receiving a very weak signal, turn OFF the squelch function.

### Use the speaker switch

The audio output through the internal speaker can be muted with [SP OFF]. This is useful when you do not need to listen to receive signals, as when external equipment is connected to the rear panel ACC socket.

### Adjust [CLARITY]

This control shifts the receive frequency up to  $\pm 150$  Hz to the displayed receive frequency. This allows clear reception for an off frequency signal.

### Receive indicator

When a signal is received and the squelch opens, the RECEIVE indicator lights.

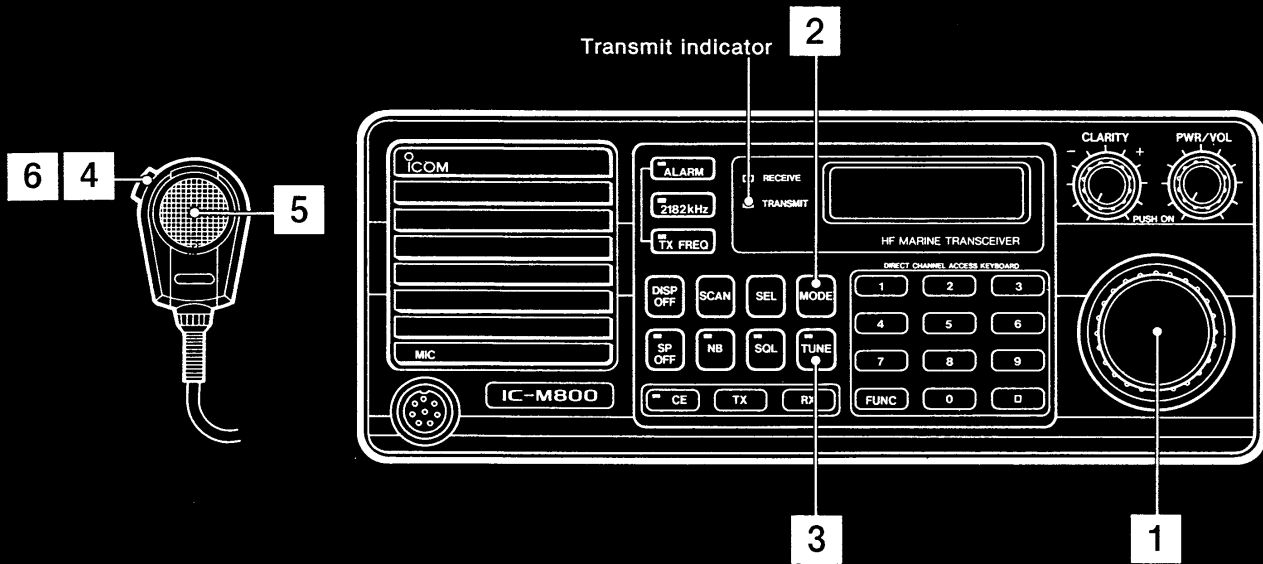

## ■ Transmitting

The following transmitting procedures should be started after completing the steps in Section 8 RECEIVING.

- 1** Select the desired operating channel or frequency.
  - For selecting a channel, see p. 13.
  - For setting a frequency, see p. 14.
- 2** Push [MODE] to select the desired operating mode.
- 2** Push [TUNE] when an optional AT-120 HF AUTOMATIC ANTENNA TUNER is connected.
  - Push [TUNE] each time you have changed the operating channel.
  - The AT-120 automatically tunes the connected antenna wire (or element).
  - The TUNE indicator lights while the AT-120 is tuning.
  - The [TUNE] switch only functions when the AT-120 is connected to the IC-M800.
- 4** Push and hold the PTT switch on the microphone.
  - The TRANSMIT indicator lights.
  - The RF indicator appears.
  - See the terminal unit instruction manual when operating FSK.
- 5** Speak into the microphone at your normal voice level.
  - The RF indicator varies depending on your voice level.
- 6** Release the PTT switch to receive.

### **TX FREQ** Use the transmit frequency check switch

While holding this switch, the function display changes from the receive frequency to transmit frequency. This function is useful for checking whether the transmit frequency is busy or not.

# 10 WRITING A FREQUENCY

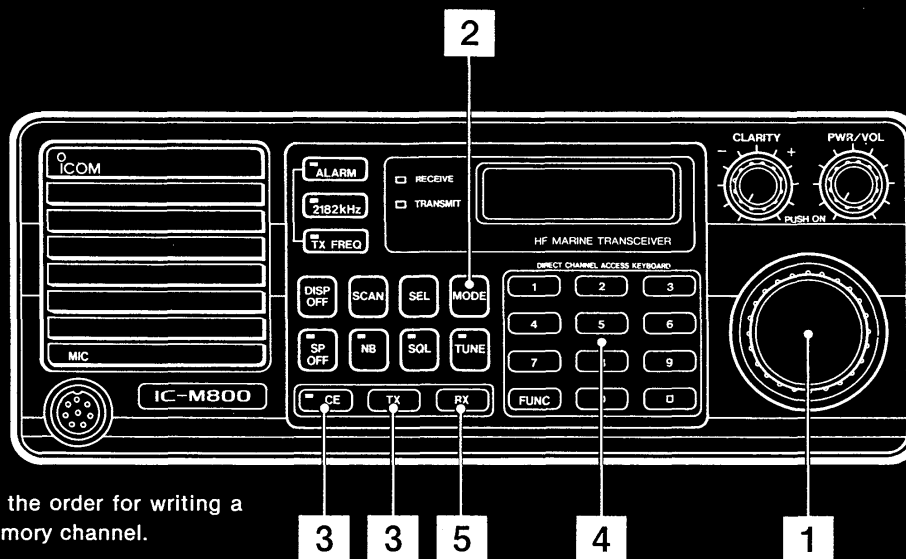

The diagram shows the order for writing a frequency into a memory channel.

## ■ Writing a frequency

The IC-M800 has 160 user-programmable memory channels.

- 1 Select the desired memory channel to be stored.
  - For selecting a memory channel, see p. 13.
- 2 Push [MODE] to select the desired operating mode.
- 3 Push [CE].
  - The CE indicator lights.
- 4 Push number keys on the 10-keyboard to select the desired frequency to be stored. (See p. 14)
- 5 Push [RX] or [TX]:
  - Push [RX] to store the frequency as a receive frequency.
  - Push [TX] to store the frequency as a transmit frequency.

**NOTE:** The ITU simplex channels can be programmed to your desired frequency. 9 simplex channels are available for each band.

## ■ Clearing memory information

- 1 Select the desired memory channel to be cleared.
  - For selecting a memory channel, see p. 13.
- 2 Push [CE]. Then push [0].
- 3 Push [RX] or [TX]:
  - Push [RX] to clear the receive frequency.
  - Push [TX] to clear the transmit frequency.

## ■ Writing a comment

Up to 7 characters can be stored in each memory channel for your reference.

- 1 Push [FUNC] then push [CE].
    - The cursor appears under the character in the bottom left corner.
- 
- 2 Rotate the main dial to select the desired character.
    - To clear the programmed comment, select each space and write over the characters.
  - 3 Push [RX] to set the character and move the cursor to the right for the next setting.
    - To clear an entry, push [CE].



- 4 Push [TX] to set all characters and return to normal operating conditions.



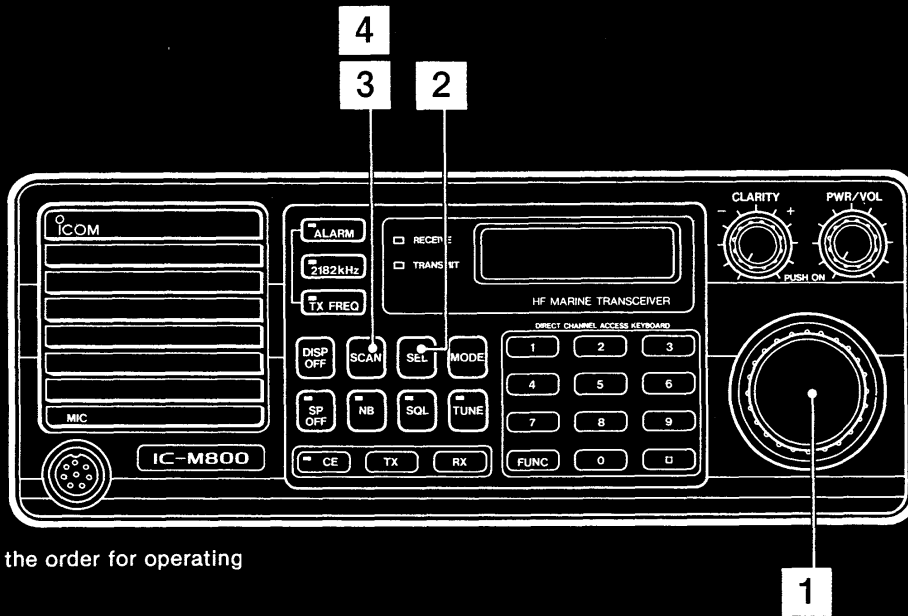

The diagram shows the order for operating the scan.

## ■ Scanning

The transceiver scans desired memory channels between 1~160. Scan channels are set as follows:

- 1 Select the desired memory channels to be scanned.
  - For selecting a memory channel, see p. 13.
- 2 Push [SEL] to set the channel as a scan channel.
  - “\*” appears.



- 3 Push [SCAN] to start the scan.
  - “SCAN” appears.
  - Scanning does not stop even when a signal is received.



- 4 To stop the scan, push [SCAN] again.
  - “SCAN” disappears.



- 3 To change the scan speed, see instructions at right for selecting a scan speed.

## ■ Scanning with external equipment

The transceiver can be set to stop scanning when external equipment is connected to the ACC(1) socket. See p. 12 for connection information. See p. 23 for internal switch setting information.

### ■ Selecting a scan speed

There are 10 selectable scan speeds.

- 1 Push [FUNC] then push [SCAN].
  - “SCAN” and the previously selected scan speed number appear.



- 2 Push the desired number to determine the scan speed.

- [1]-key: Approx. 1 sec. for each channel
- [2]-key: Approx. 2 sec. for each channel
- [3]-key: Approx. 3 sec. for each channel
- "          "
- "          "
- "          "
- [0]-key: Approx. 10 sec. for each channel



- 3 To stop the scan, push [SCAN] again.
  - “SCAN” disappears.

# 12 ALARM SIGNAL

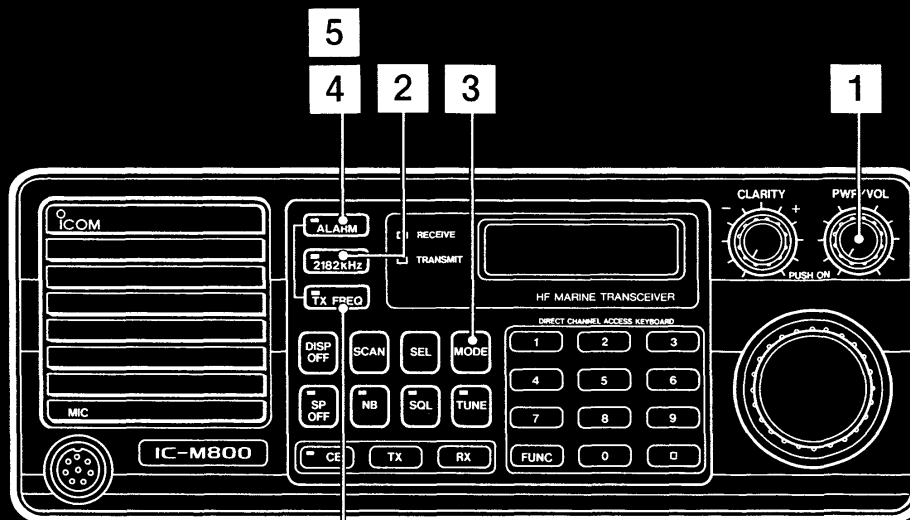

The diagram shows the order for transmitting an alarm signal.

**4**  
(Push and hold)

## ■ Transmitting an alarm signal

The transceiver can transmit a 2-tone alarm signal on any HF marine frequency including 2182 kHz.

- 1** Push [PWR/VOL] to turn ON power.
- 2** Select the desired frequency to transmit alarm signals:
  - Push [2182 kHz] to quickly select 2182 kHz.
  - See p. 13 for selecting a channel.



- 3** Push [MODE] to select the desired operating mode, if necessary.
- 4** Push and hold [TX FREQ] then push [ALARM].
  - The TRANSMIT indicator lights.
  - 2-tone alarm signals are transmitted for approx. 50 seconds.



- 5** To stop transmitting the signal, push [ALARM] again.

## ■ Testing an alarm signal

An alarm signal can be checked without transmitting.

- 1** Push [ALARM].
  - The speaker emits alarm signals for approx. 50 seconds.
- 2** To stop testing, push [ALARM] again.

## ■ Distress call procedures

If your vessel requires assistance, contact other vessels and the Coast Guard by sending a distress call on 2182 kHz.

1. "MAYDAY MAYDAY MAYDAY"
2. "THIS IS ....." (name of vessel)
3. "LOCATED AT ....." (Vessel's position)
4. Give the reason for the distress call.
5. Explain what assistance you need.
6. Give additional information:
  - Vessel type
  - Vessel length
  - Vessel color

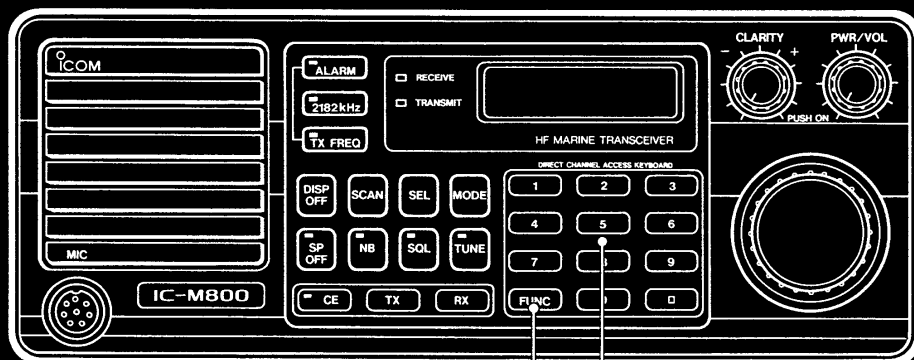

The diagram shows the order for changing the display contrast.

1 2

## ■ Changing the display contrast

The contrast of displayed characters can be varied in 7 steps. Change the contrast to suit ambient light conditions.

- 1 Push [FUNC].
- 2 Push one of the desired keys from [1]~[7] to alter the display contrast.
  - [1]-key: Heaviest contrast
  - [7]-key: Lightest contrast

## ■ Turning the display backlight ON/OFF

The display backlight can be turned ON and OFF for easy reading in dark environments. Use the function with the display contrast adjustment as described below.

Alternately pushing [DISP OFF] turns the backlight ON and OFF.

# 14 MULTI-CONTROLLER OPERATION (OPTIONAL)

## ■ Connecting remote controllers

Up to 4 remote controllers (optional) can be connected to the transceiver for operating from different places.

See the figure below for installing more than 2 remote controllers. The transceiver needs the following options:

- EX-803 REMOTE CONTROLLER
- EX-804 EXPANDER UNIT

## ■ Priority of the clarity control

A remote controller using clarity control can be given priority over other controllers.

- 1 Push [□] to set the controller having clarity control priority.
- 2 To change priority to another controller, push [□] on the desired controller.

## ■ Operation note

Operations using more than 2 remote controllers are basically the same as the operations with one controller. See each section regarding each function or operation. However, some switches and controls are interlocked with other controllers.

INTERLOCKING FUNCTIONS
Alarm signal testing with [ALARM].
Alarm signal transmission with [TX FREQ] and [ALARM].
2182 kHz selection with [2182kHz].
Transmit frequency checking with [TX FREQ].
Transmit/receive switching with the PTT switch.
Channel selection with the main dial.
Channel selection with the 10-keyboard.
Mode selection with [MODE].
Scan channel selection with [SEL].
Scanning start/stop control with [SCAN].
Antenna tuner tuning with [TUNE].
Squelch function ON/OFF with [SQL].
Noise blanker ON/OFF with [NB].
Clarity control with [CLARITY].

INDEPENDENT FUNCTIONS
Power ON/OFF with [PWR/VOL].
Speaker output volume level with [PWR/VOL].
Display backlight ON/OFF with [DISP OFF].
Speaker output muting ON/OFF with [SP OFF].
Function display contrast with [FUNC] and number key.

### ● Connecting an extra remote controller

1. Attach the EX-804 EXPANDER UNIT (optional)
2. Connect the supplied DC power cable and interface cable as shown at right.

EX-804 EXPANDER UNIT (optional)

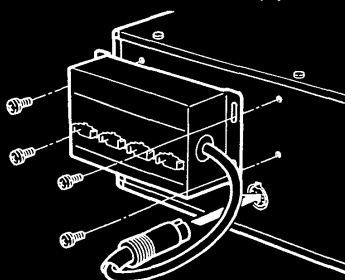

IC-M800 REMOTE CONTROLLER

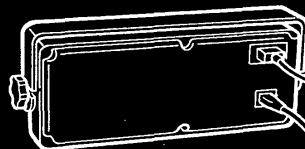

IC-M800 TRANSCEIVER

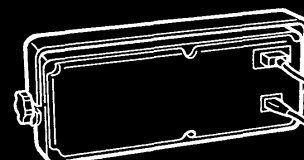
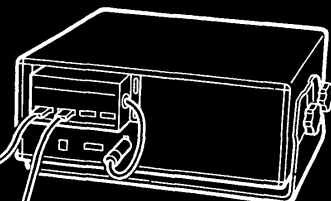

EX-803 REMOTE CONTROLLER (optional)

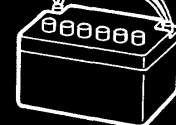

12 V battery



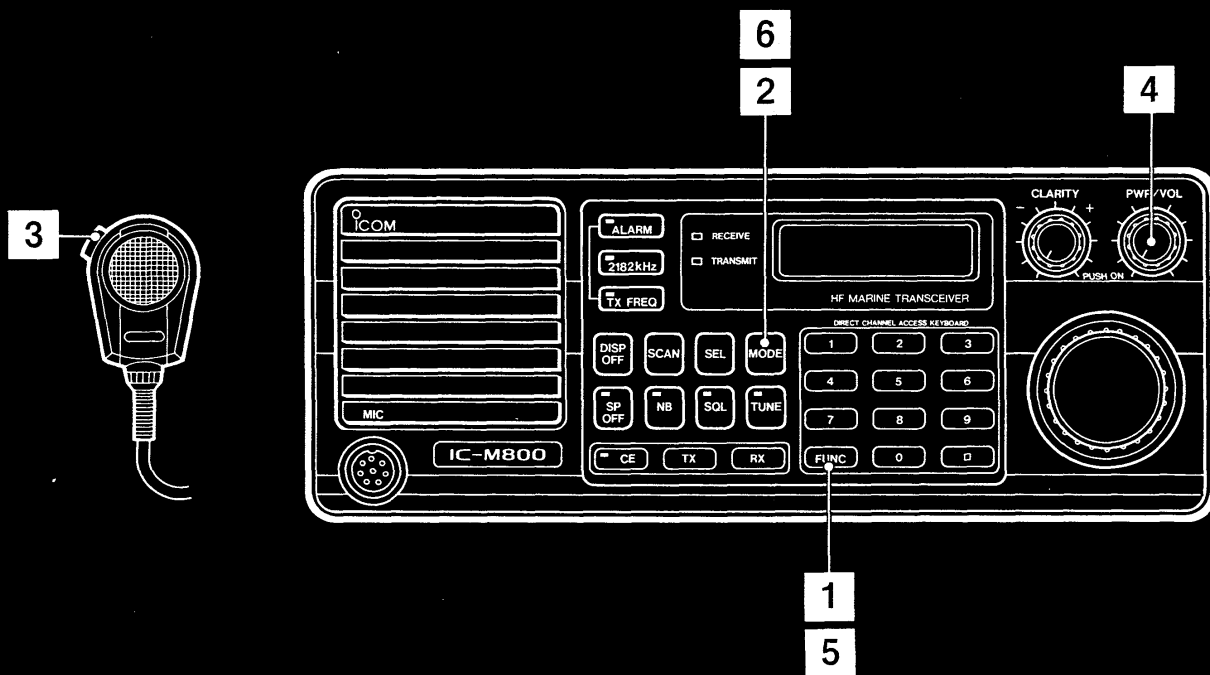

## ■ Operating the intercom function

The intercom function allows you to talk to the deck from the cabin or vice versa. More than 2 controllers (optional) are necessary for using this function.

**1** Push [FUNC].

**2** Push [MODE].

- "-- INTERCOM --" appears.



**3** Push and hold the PTT switch on the microphone and speak into the microphone.

- Your voice is transferred to other controllers.

**4** To adjust audio level through the speaker on the receive side, rotate [PWR/VOL].

**5** To cancel the intercom function, push [FUNC] then push [MODE] again.

See p. 21 for connecting more than 2 remote controllers to the transceiver.

## ● Intercom simulation

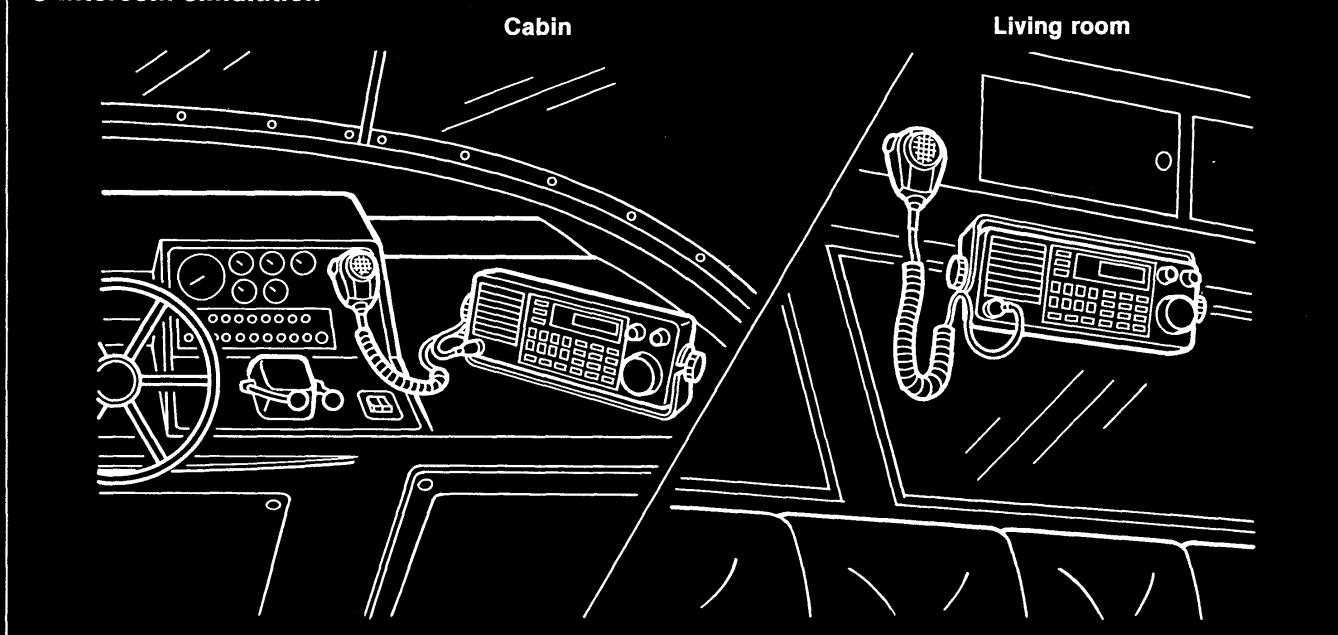

**S1 CW break-in selector switch**

When operating the transceiver in CW full break-in mode.



When operating the transceiver in CW mode in manual transmitting.

**S3 Scan control switch**

Scan does not stop regardless of squelch conditions. The scan start/stop can be controlled when:

- [SQL] on the front panel is pushed.
- a "LOW" or "HIGH" level signal enters ACC(1) pin 6.



The scan stops and resumes according to squelch conditions when a "LOW" level signal is applied to ACC(1) pin 6. However, [SQL] does not function to start and stop the scan.

**R190 Tuning power adjustment pot**

Not adjustment necessary. The power is set at 10 W for an optional AT-120 HF AUTOMATIC ANTENNA TUNER at the factory.

Space for an optional FL-32A. See p. 24 for the installation.

**CAUTION:** Your IC-M800 has been thoroughly adjusted and checked at the factory before being shipped. Transceiver warranty does not cover problems caused by unauthorized internal adjustments.

**S4 Filter selector switch**

2.3 kHz/-6 dB SSB filter is selected when operating in CW and FSN (FSK narrow) modes.



500 Hz/-6 dB narrow filter (optional) is selected when operating in CW and FSN (FSK narrow) modes.

**S2 S/RF indicator selector switch**

Set switch in this position.



Does not function in this position.

**R25 Squelch sensitivity adjustment pot (CW, FSK)**

Clockwise rotation increases the squelch sensitivity in CW, FSW and FSN modes.

**R177 Squelch sensitivity adjustment pot (AM, SSB)**

Clockwise rotation increases the squelch sensitivity in LSB, USB, AM and A3H modes.

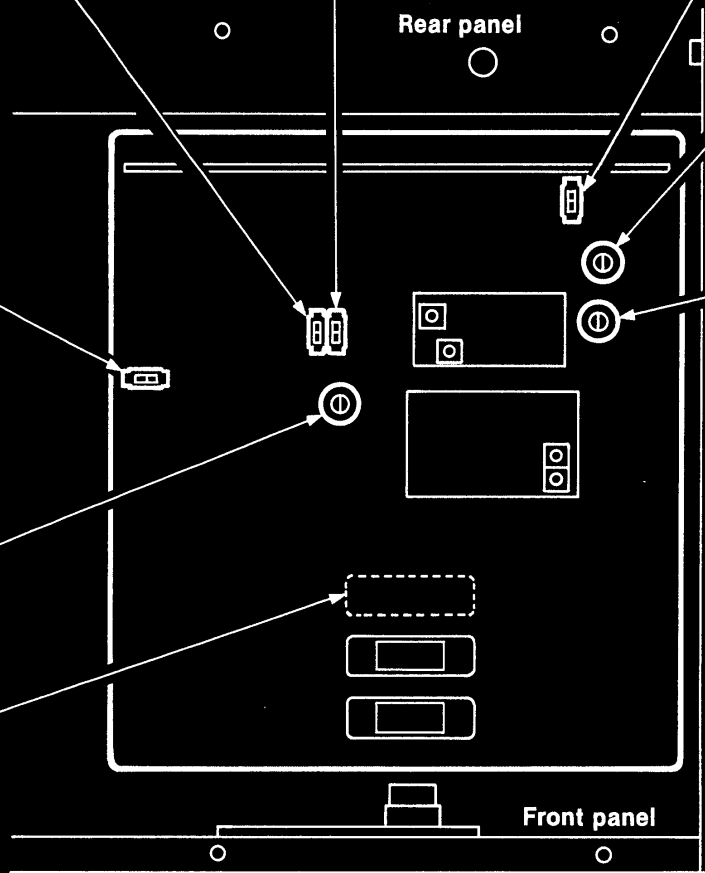

The P.C. board is located under the transceiver top cover.

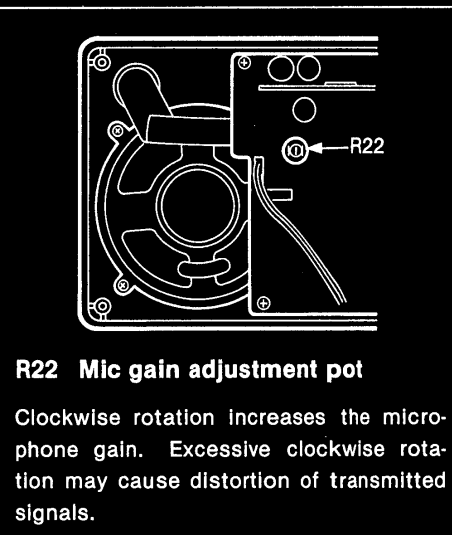
**R22 Mic gain adjustment pot**

Clockwise rotation increases the microphone gain. Excessive clockwise rotation may cause distortion of transmitted signals.

## ■ Replacing a fuse

If the fuse blows or the transceiver stops functioning, find the source of the problem if possible, and replace the damaged fuse with a new, rated fuse. See diagrams below for replacing the fuse.

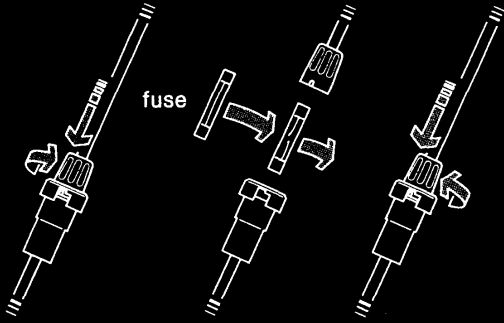

The IC-M800 has fuses installed in 3 different places:

- Transceiver DC power cable: 30 A
- Controller DC power cable : 3 A
- Inside the transceiver : 5 A

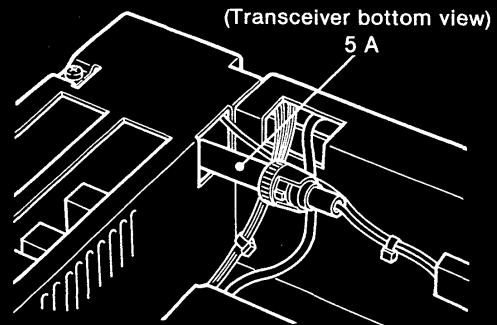

## ■ Installing an optional FL-32A filter

1. Unscrew 10 screws and lift up the MAIN unit.
2. Unsolder the 6 positions on the P.C. board where the FL-32A will be installed. See p. 23 for the installation position. Use a de-soldering braid.
3. Install the filter in the proper direction.
4. Solder the filter leads and trim them even with the solder points.
5. Replace the P.C. board and the cover.

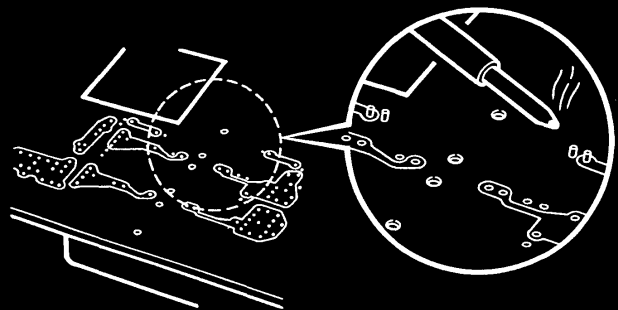
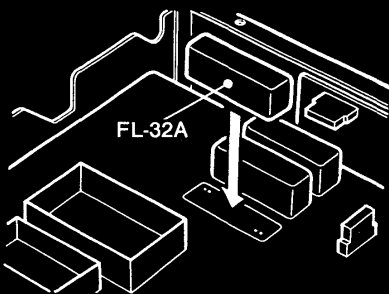

**NOTE:** Switch S4 to the other position when the filter is installed. See p. 23 for S4 position.

## ■ Resetting the microprocessor

If the function display occasionally displays erroneous information during operation or when first applying power, reset the microprocessor. Reset as follows:

1. Disconnect the transceiver DC power cable.
2. Disconnect the controller DC power cable.
3. Wait a few minutes, then connect both DC power cables securely.
4. Push [PWR/VOL] to turn ON power.

## ■ Cleaning

If the transceiver becomes dusty or dirty, wipe it clean with a dry, soft cloth.

**AVOID** the use of strong chemical agents such as benzene or alcohol, as they may damage the transceiver surfaces.



# 18 TROUBLESHOOTING

What may appear to be trouble at first is not always a problem. Check the following chart before making any adjustments or sending the transceiver to an Icom Service Center.

	PROBLEM	POSSIBLE CAUSE	SOLUTION	REF.
POWER	• Power does not come ON when [PWR/VOL] is pushed.	• Power cable is improperly connected. • Blown fuse	• Reconnect the cable securely. • Check for the cause, then replace the fuse with a spare one. 3 kinds of fuses are installed in different places.	p. 10 p. 24
	• No sound comes from the speaker.	• Volume level is too low. • The squelch is closed. • The speaker switch is set at ON. • Microphone is not connected to [MIC].	• Rotate [PWR/VOL] CW to suit your listening level. • Push [SQL] to open the squelch. • Push [SP OFF] to set at OFF. • Connect the supplied microphone to [MIC].	p. 15 p. 15 p. 15 p. 15
RECEIVE	• Sensitivity is low and only strong signals are audible.	• Antenna is not properly matched at the operating frequency. • Bad connection of the antenna connector or element.	• Push [TUNE] to tune the connected antenna system when an optional AT-120 is connected. • Check the antenna system and correct any improper condition.	p. 16 p. 10
	• Received audio is unclear or distorted.	• Wrong mode is selected. • [NB] is ON when receiving a strong signal. • [CLARITY] is rotated too far CW or CCW.	• Push [MODE] to select the proper operating mode. • Push [NB] to turn OFF. • Adjust [CLARITY] to receive proper audio output.	p. 15 p. 15 p. 15
	• Your signal does not reach distances as far away as usual.	• Antenna is not properly matched at the operating frequency.	• Push [TUNE] to tune the connected antenna system when an optional AT-120 is connected.	p. 17
	• Transmitted signal is unclear or distorted.	• Wrong mode is selected. • Microphone is held too closely to your mouth.	• Push [MODE] to select the proper operating mode. • Speak into the microphone naturally and do not hold the microphone too closely to your mouth.	p. 16 p. 16
TRANSMIT	• No contact is possible with another station.	• Wrong transmit frequency is set.	• Push [TX FREQ] to check the transmit frequency and store the correct transmit frequency.	p. 16
	• Frequency cannot be changed in 100 Hz steps.	• [CE] is not pushed.	• Push [CE] first then rotate the main dial.	p. 14
	• Frequency cannot be set by the 10-keyboard.	• [CE] is not pushed before entering the frequency.	• Push [CE] to enter the desired frequency by the 10-keyboard then push [RX] or [TX].	p. 14
	• The desired mode is not selected.	• An ITU channel is selected.	• Select user-programmable channel first, then push [MODE] to select the desired mode.	p. 13
	• The function display backlight does not light.	• [DISP OFF] is activated.	• Push [DISP OFF] to turn ON the display backlight.	p. 20
FUNCTION DISPLAY	• The display characters are unreadable.	• The display contrast is very light.	• Push [FUNC] then push [1] to obtain the heaviest contrast.	p. 20
	• The function display indicates erroneous information.	• Internal CPU may have malfunctioned causing static electricity or other problems.	• Push [PWR/VOL] to turn OFF power. Wait a few seconds, then turn ON power again.	p. 24
	• The function display does not change any information with any switch.	• The interface cable between the controller and transceiver is not completely connected. • The intercom function is activated.	• Check the cable connection and correct any improper condition then turn OFF power and ON again. • Push [FUNC] then push [MODE].	p. 8 p. 22
	SCAN	• Scan does not start.	• An ITU channel is selected. • Only one scan channel is selected as scan channels. • Scan channels are not selected. • 2182 kHz is selected with [2182kHz].	• Select a user-programmable channel then push [SCAN]. • Set channels as scan channels for more than 2. • Set channels as scan channels with [SEL]. • Push [2182kHz] then push [SCAN].

## ■ User-programmable memory channel

CHANNEL NUMBER	DESCRIPTION
1~160	User-programmable memory channel

## ■ ITU channel list (SSB)

CHANNEL NUMBER	DESCRIPTION
401~427	4 MHz ITU duplex channel for SSB
4-1~4-9	4 MHz ITU simplex channel for SSB
601~608	6 MHz ITU duplex channel for SSB
6-1~6-9	6 MHz ITU simplex channel for SSB
801~832	8 MHz ITU duplex channel for SSB
8-1~8-9	8 MHz ITU simplex channel for SSB
1201~1241	12 MHz ITU duplex channel for SSB
12-1~12-9	12 MHz ITU simplex channel for SSB
1601~1656	16 MHz ITU duplex channel for SSB
16-1~16-9	16 MHz ITU simplex channel for SSB
1801~1815	18 MHz ITU duplex channel for SSB
18-1~18-9	18 MHz ITU simplex channel for SSB
2201~2253	22 MHz ITU duplex channel for SSB
22-1~22-9	22 MHz ITU simplex channel for SSB
2501~2510	25 MHz ITU duplex channel for SSB
25-1~25-9	25 MHz ITU simplex channel for SSB

## ■ ITU channel list (FSK)

CHANNEL NUMBER	DESCRIPTION
401~417	4 MHz ITU duplex channel for FSK
4-1~4-9	4 MHz ITU simplex channel for FSK
601~629	6 MHz ITU duplex channel for FSK
6-1~6-9	6 MHz ITU simplex channel for FSK
801~834	8 MHz ITU duplex channel for FSK
8-1~8-9	8 MHz ITU simplex channel for FSK
1201~1307	12 MHz ITU duplex channel for FSK
12-1~12-9	12 MHz ITU simplex channel for FSK
1601~1732	16 MHz ITU duplex channel for FSK
16-1~16-9	16 MHz ITU simplex channel for FSK
1801~1822	18 MHz ITU duplex channel for FSK
18-1~18-9	18 MHz ITU simplex channel for FSK
2201~2301	22 MHz ITU duplex channel for FSK
22-1~22-9	22 MHz ITU simplex channel for FSK
2501~2520	25 MHz ITU duplex channel for FSK
25-1~25-9	25 MHz ITU simplex channel for FSK

# 20 SPECIFICATIONS

ITEM		DESCRIPTION
<b>■ General</b>		
Frequency coverage	Receive	0.5~30.0 MHz continuously
	Transmit	2.0000~2.9999 MHz 4.0000~4.9999 MHz 6.0000~6.9999 MHz 8.0000~8.9999 MHz 12.0000~13.9999 MHz 16.0000~16.9999 MHz 18.0000~19.9999 MHz 22.0000~22.9999 MHz 25.0000~26.4999 MHz
Mode	J3E (USB, LSB), H3E, R3E, A3E (receive only), A1A, J2B	
Antenna Impedance	50 Ω (unbalanced)	
Power supply requirement	13.6 V ± 15% DC (negative ground)	
Current drain	Receive	2 A at max. audio output
	Transmit	30 A at max. RF output power
Usable temperature range	-30 °C ~ +60 °C (-22 °F ~ +140 °F)*	
Frequency stability	±15 Hz for 0.1~23 MHz (-30°C ~ +60°C; -22 °F ~ +140 °F)	
Dimensions	Transceiver	287(W) × 112(H) × 325(D) mm 11.3(W) × 4.4(H) × 12.8(D) in
	Remote controller	287(W) × 112(H) × 62(D) mm 11.3(W) × 4.4(H) × 2.4(D) in (Projections not included)
Weight	Transceiver	6.5 kg (14.3 lb)
	Remote controller	1.0 kg (2.2 lb)
<b>■ Transmitter</b>		
Output power	150 W (60 W: 25.0000~26.4999 MHz)	
Spurious emissions	65 dB below peak output power	
Carrier suppression (SSB)	50 dB below peak output power	
Unwanted sideband suppression	55 dB below peak output power (with 1000 Hz AF input)	
Microphone impedance	600 Ω	
<b>■ Receiver</b>		
Sensitivity (for 12 dB SINAD)	SSB, CW, FSK	0.5~1.8 MHz 6.3 μV 1.8~30.0 MHz 0.5 μV
	AM	0.5~1.8 MHz 30 μV 1.8~30.0 MHz 3.16 μV
Spurious response rejection	-70 dB	
Audio output power	5.0 W with a 4 Ω load	
Audio output impedance	4~8 Ω	
Clarity variable range	±150 Hz in 10 Hz steps	

\* The function display on the remote controller may not indicate characters clearly under extremely low temperatures around -30 °C (-22 °F) due to LCD characteristics. However, transmitting and receiving with the IC-M800 function normally around this temperature.

## EX-804 EXPANDER UNIT

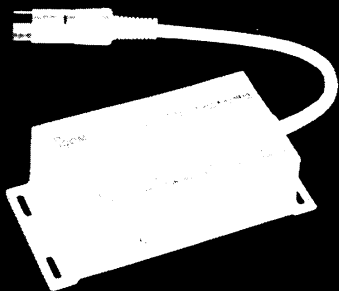

Required when connecting more than 2 controllers to the transceiver for multi-controller operation.

## EX-803 REMOTE CONTROLLER

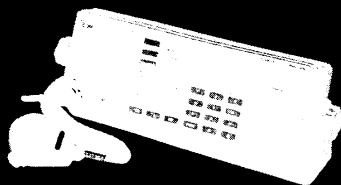

This is an extra controller for multi-controller operation and comes with a DC power cable, interface cable, mounting bracket and microphone.

## AT-120 HF AUTOMATIC ANTENNA TUNER

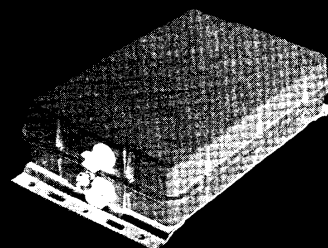

Matches the IC-M800 to a long wire or whip antenna system.

## MN-100/MN-100L ANTENNA MATCHERS

MN-100



MN-100L

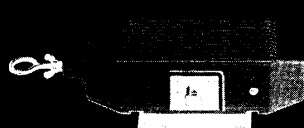

Matches the IC-M800 to a long wire or whip antenna system without applying DC power. An antenna matcher is recommended for emergency situations.

## PS-60 AC POWER SUPPLY

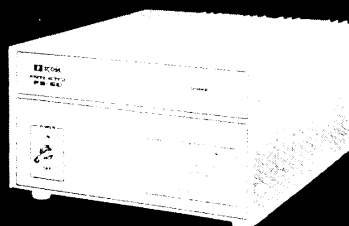

Provides 13.6 V DC (30 A) output from an AC outlet.

## PS-65/PS-66 DC-DC CONVERTERS

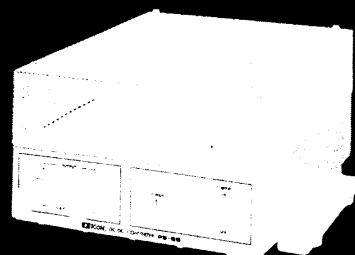

Convert a DC voltage to 13.6 V (30 A) and provide a floating ground system.

- PS-65: Input voltage 10.5~16 V
- PS-66: Input voltage 19~32 V

## HS-50 HANDSET

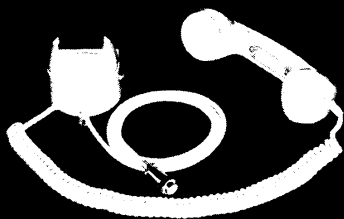

Provides better audio reception and comes in handy for listening privacy onboard. (The connector may differ from that shown in the picture above.)

## FL-32A CW NARROW FILTER

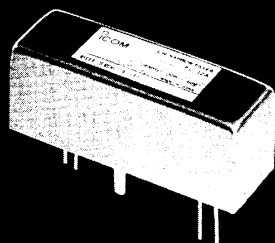

Has good shape factor and provides you with better receiver selectivity in CW and FSK operation.

- Bandwidth : 500 Hz / -6 dB

## EXTENSION INTERFACE CABLE

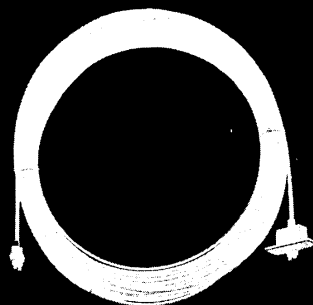

Provides longer-separation remote control operation for the transceiver.

- Cable length: 20 m (65 ft)

Count on us!

