

**ICOM**

**INSTRUCTION MANUAL**

VHF TRANSCEIVER

**IC-V210T**

UHF TRANSCEIVER

**IC-U210T**



**Icom Inc.**

---

## IMPORTANT

---

**READ ALL INSTRUCTIONS** carefully and completely before using the transceiver.

### **SAVE THIS INSTRUCTION MANUAL —**

This instruction manual contains important safety and operating instructions for the **IC-V210T** and **IC-U210T**.

---

## FOREWORD

---

Thank you for choosing the **IC-V210T VHF TRANSCEIVER** or **IC-U210T UHF TRANSCEIVER**. Since the **IC-V210T** and **IC-U210T** are equipped with both 5-tone and CTCSS capability, it can be used with almost all types of business band transceivers.

This instruction manual explains the basic operation for the **IC-V210T/IC-U210T**. The way to use the **IC-V210T/IC-U210T** varies widely depending on the internal programming. Please ask your dealer for further information.

---

## CAUTIONS

---

**NEVER** connect the transceiver to AC or a 24 V DC car battery.

**NEVER** allow children to touch the transceiver.

**NEVER** expose the transceiver to rain, snow or any liquids or place the transceiver in a dusty environment or in direct sunlight.

**NEVER** disassemble the transceiver. Incorrect reassembly may result in a fire hazard or electric shock.

**NEVER** place the transceiver where normal operation of the vehicle may be hindered or where it could cause bodily injury.

**DO NOT** use the transceiver when it is covered by objects which impede heat dispersion.

**AVOID** using or storing the transceiver in places with temperatures below  $-25^{\circ}\text{C}$  or over  $+55^{\circ}\text{C}$ .

**BE CAREFUL!** The heatsink may become hot when operating the transceiver for a long period.

## TABLE OF CONTENTS

1. PANEL DESCRIPTION .....	1~2
■ Front panel .....	1
■ Function display .....	2
2. BASIC OPERATION .....	3~4
■ Receiving .....	3
■ Transmitting .....	3
3. GENERAL DESCRIPTION .....	5~6
■ Channels .....	5
■ Conditions .....	6
4. SCAN FUNCTION .....	7
5. OPTIONAL FUNCTIONS .....	8~10
■ For receiving .....	8
■ For transmitting .....	10
6. 5-TONE OPERATION EXAMPLE .....	11
7. OPTIONS .....	12

## UNPACKING

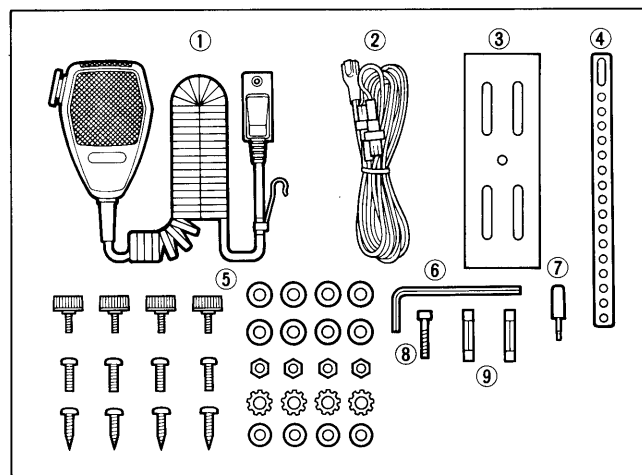

### ACCESSORIES:

### QTY.

① Microphone (EM-63) .....	1
② DC power cable (OPC-044A) .....	1
③ Mounting bracket .....	1
④ Mounting support plate .....	1
⑤ Mounting bracket screw, nut and screws .....	1 set
⑥ Allen key wrench .....	1
⑦ External speaker plug .....	1
⑧ Allen head screw .....	1
⑨ Spare fuses (10 A) .....	2

# 1

## PANEL DESCRIPTION

### ■ Front panel

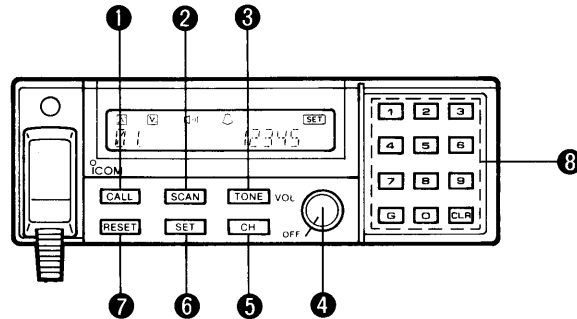

#### ① CALL SWITCH [CALL]

Transmits a TX 5-tone code.

#### ② SCAN SWITCH [SCAN]

Starts and stops scanning.

- This switch does not function on the non-scan type.

#### ③ TONE SWITCH [TONE]

Selects a TX 5-tone channel with the keyboard.

#### ④ POWER SWITCH/VOLUME CONTROL [VOL]

- Turns the power ON and OFF and adjusts the audio output level.

- Opens or closes the squelch by pulling or pushing, respectively.

#### ⑤ CHANNEL SWITCH [CH]

Selects a memory channel with the keyboard.

#### ⑥ SET SWITCH [SET]

- Selects the display brightness, bright or dark.
- Selects TX 5-tone code indication or TX comment indication when pushing and holding for 4 sec.

#### ⑦ RESET SWITCH [RESET]

Selects the reset or monitor condition.

- The monitor condition may or may not be selectable depending on the transceiver type.

#### ⑧ KEYBOARD

Selects the memory channel number or TX 5-tone channel number.

## ■ Function display

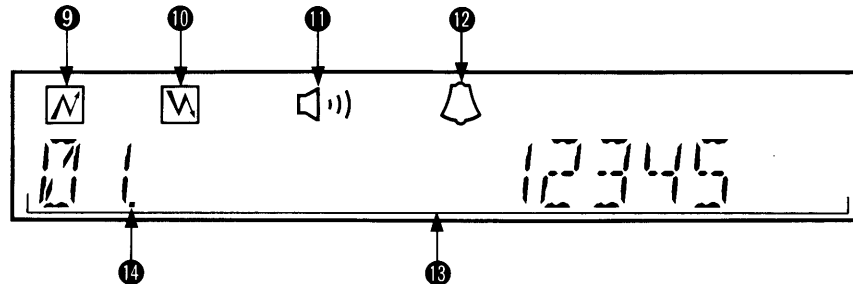

### 9 TRANSMIT INDICATOR

Appears when transmitting.

### 10 BUSY INDICATOR

Appears when the selected channel is busy.

### 11 MONITOR INDICATOR

Appears when the transceiver is in the monitor condition.

### 12 BELL INDICATOR

Can be displayed or blinked when the 5-tone code for you is received.

- This is an optional function. Ask your dealer for details.

### 13 FUNCTION INDICATOR

Displays the channel number, 5-tone code, TX comment, etc.

### 14 SCAN CHANNEL INDICATOR

“•” appears when the selected channel is a scan channel.

## ■ Receiving

- 1) Rotate [VOL] to turn power ON.
  - When "PASSWORD" appears, enter the password. (p. 8)
  - When "SCANNING" appears, skip step 2 and proceed from step 3.
- 2) When your transceiver is a multi-channel type, push a digit key to select the memory channel.
  - Some types require pushing [CH] before digit input. See p. 4 "Channel selection" for details.
- 3) Set [VOL] to the 10 o'clock position.
- 4) When the call signal is received, either the function display shows the received code or the received voice is heard from the speaker.
  - Beep or external alarm device may sound to inform you. (p. 9)
  - Scan may start automatically. (p. 7)
- 5) Perform transmit operation or push [RESET] to wait for the next call.
- 6) To turn power OFF, rotate [VOL] fully counter-clockwise until a click is heard.

## ■ Transmitting

**NOTE:** DO NOT transmit while "ⓧ" appears. Your transmission may interfere with other communications.

- 1) When you call a station using the 5-tone code, perform "Calling operation" at right.
  - After receiving a call or when the channel does not use a 5-tone code, skip this step.
- 2) Push and hold the PTT switch to transmit the voice signal. Then, speak into the microphone.
  - DO NOT hold the microphone too closely to your mouth or speak too loudly.
- 3) To return to receive, release the PTT switch.
- 4) Push [RESET] when communication has ended.

### TRANSMITTING NOTE

- If "ⓧ" does not appear, transmission may be impossible. (p. 6)
- T.O.T. function may act automatically to stop transmission. (p. 10)
- Transmitting may be impossible on some channels. (p. 10)

### CALLING OPERATION

1. Select the TX 5-tone channel.
  - Push [TONE] then input the channel number (2 digits).
  - See the box at right for channel selecting procedure.

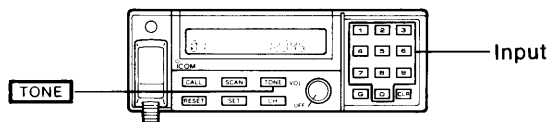

2. Be sure "M" is NOT indicated.
  - If "M" is indicated, wait until the indicator disappears.

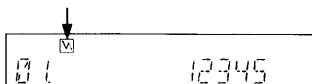

3. Push [CALL] to transmit the TX 5-tone code.
  - An answer back call from the other station may appear on the function display.

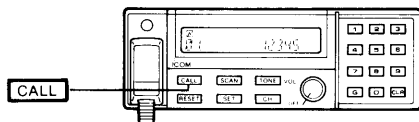

4. Proceed to transmitting operation when the channel accepts voice transmission.

### CHANNEL SELECTION

**DIRECT SELECTING:** Selects either the memory channel or TX 5-tone channel directly by pushing any digit key.

- Push the digit key of a memory channel or a TX 5-tone channel number.
  - This method is only effective for channels 0~9.

To select non-corresponding channels or channels 10~99, follow "NORMAL SELECTING" procedure.

**NORMAL SELECTING:** Selects both the memory channel and TX 5-tone channel.

- Push [CH] ([TONE]\*), and then enter the channel number (2 digits) from the keyboard.
  - This method is effective for all programmed channels.
    - \* For TX 5-tone channels.

#### NORMAL SELECTING EXAMPLE

- When selecting memory channel 19.  
Push **CH** **1** **9**.
- When selecting TX 5-tone channel 3.  
Push **TONE** **0** **3**.

## Channels

2 types of channels are used to operate the transceiver.

- Memory channel
- TX 5-tone channel

### (1) Memory channel

A memory channel is used as an operating channel. You can select the desired memory channel using the memory channel number that appears on the left side of the function display.

The number of memory channels depends on the transceiver type.

2 types of memory channels are available.

#### ① CTCSS memory channel

This channel is only effective for CTCSS.



#### ② 5-tone memory channel

This channel is only effective for 5-tone.



### (2) TX 5-tone channels

TX 5-tone channels contain TX 5-tone codes and are used with 5-tone memory channels for selective calling to other stations.

You can select the TX 5-tone channel on these memory channels. The number of TX 5-tone channels depends on the transceiver type.

#### TX 5-tone code indication      Comment indication

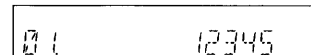
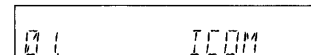
TX 5-tone channel numbers do not appear on the function display, but they are indicated by the TX 5-tone code or the comment.

- To change the display mode (indication of TX 5-tone code or comment), push and hold [SET] for 4 sec.

**NOTE:** All digits of the 5-tone code may not be displayed. The digits which will be displayed are restricted depending on the transceiver type.



## Conditions

For 5-tone operation 2 types of conditions exist.

- Reset condition
- Monitor condition

**NOTE:** For operation on CTCSS memory channels, these conditions exist, but operation is the same in both cases.

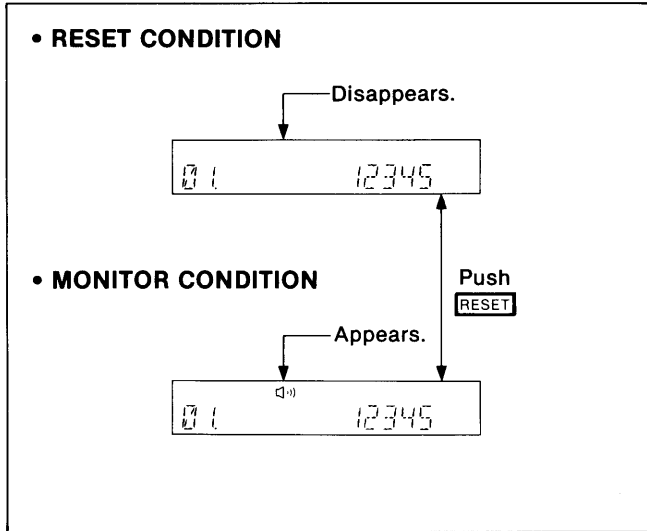

### (1) Reset condition

This is the standby condition. The transceiver usually is in the reset condition.

- “” is not indicated.
- No signals are heard from the speaker.
- Voice transmission is impossible.
- The squelch cannot be opened manually.

The transceiver enters the monitor condition automatically when the 5-tone signal for you is received.

### (2) Monitor condition

This is the receiving condition.

- “” is indicated.
- All received signals are heard from the speaker.
- Voice transmission is possible.
- The squelch can be opened manually.

After pushing [CALL] for call operation, the transceiver automatically enters the monitor condition.

- Push [RESET] to enter the condition manually.

**NOTE:** The [RESET] switch might not operate to enter the monitor condition. Moreover, the transceiver may not enter the monitor condition even if the 5-tone signal for you is received or after call operation depending on the transceiver type.

# 4

## SCAN FUNCTION

The scan function automatically changes the memory channels continuously at very high speed to detect a signal intended for you on all memory channels programmed as scan channels.

Push [SCAN] to start or to stop scan.

- "SCANNING" appears during scanning operation.

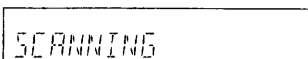

The scan pauses on a channel when the scan detects a signal for you, and the transceiver receives on that channel until the signal disappears.

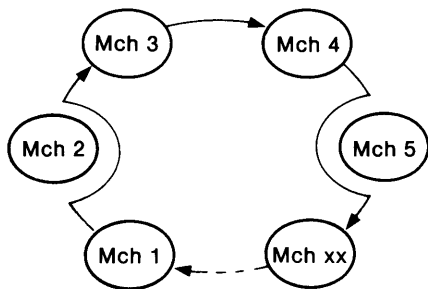

Mch 2 and Mch 5 are not programmed as scan channels.

### SCAN NOTE

The transceiver decodes the signal using either the CTCSS or 5-tone during scan operation depending on the transceiver type.

- If "CTCSS" is programmed, no 5-tone code can stop the scan; only the correct CTCSS tone can stop the scan.
- If "5-tone" is programmed, no CTCSS tone can stop the scan; only the correct 5-tone code can stop the scan.

#### When the scan function does not start:

- The transceiver is not the scan type.
- The transceiver is the single channel type.
- None or only one memory channel has been programmed as a scan channel.

## ■ For receiving

The following optional capabilities for receiving are equipped in the transceiver. Ask your dealer for further information.

### PASSWORD

The password restricts access to the transceiver. After power ON, "PASSWORD ----" appears.

- Input the correct password with the keyboard to use the transceiver.

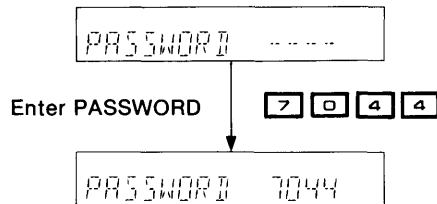

### POWER ON SCAN

After power ON, the scan automatically starts. You need not select a memory channel for receiving.

- "SCANNING" appears.
- To stop the scan, push [SCAN].
- See p. 7 for scan details.

### POWER ON MONITOR

After power ON, the transceiver automatically enters the monitor condition.

- "M" indicator appears.
- Push [RESET] to enter the reset condition to wait for selective calling.
- See p. 6 for the monitor condition.

### BEEP FUNCTION

A beep informs you that the 5-tone code for you is received. 3 types of beeps can be programmed as follows:

- Single beep
- Rapid beep
- Repeated beep

No beep is also possible. Ask your dealer for further information.

### BELL INDICATION

The bell indicator is indicated or blinked when the 5-tone code for you is received.

- This indicator is displayed until the transceiver enters the reset condition.

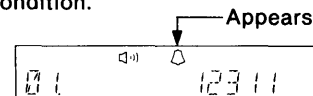

## 5 OPTIONAL FUNCTIONS

### EXTERNAL ALARM FUNCTION

An external alarm device sounds when the 5-tone code for you is received. Even if you are far from your car, you can recognize that the transceiver has received a call.

### ID CODE INDICATION

The function display shows the ID code of the transmit station instead of the receiving code. You can easily recognize the transmit station.

### ANSWER BACK TRANSMISSION

The transceiver automatically sends an answer back code when the 5-tone code for you is received to inform the transmit station of the connection.

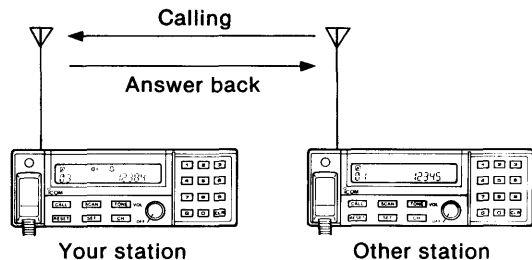

### AUTO SCAN

Scan automatically starts when the 5-tone code for you is received. When this function is activated, voice transmission is impossible.

- See p. 7 for scan details.

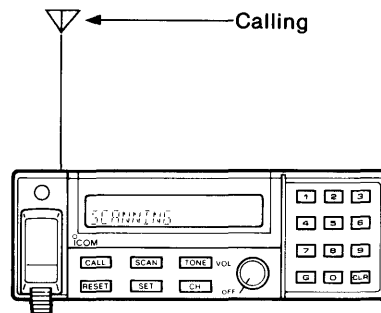

### AUTO RESET

After the 5-tone code for you is received, the transceiver automatically enters the reset condition when the programmed period ends.

### AUTO TX

Ask your dealer for information.

## ■ For transmitting

The following optional capabilities for transmitting are equipped in the transceiver. Ask your dealer for further information.

### TRANSMISSION INHIBIT

All transmission can be inhibited on some specified CTCSS or 5-tone memory channels.

- If you attempt to transmit, beeps alarm you that the selected memory channel is a transmit inhibit channel.

### TX 5-TONE CODE REWRITING

All or some digits of a TX 5-tone code can be rewritten on some TX 5-tone memory channels.

- Push [CLR], then enter the new code.
- Changeable digits are restricted depending on the transceiver type.

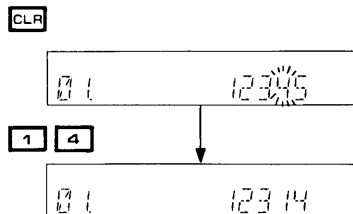

### ID CODE TRANSMISSION

Your ID code can be transmitted with a TX 5-tone code when calling. The function display of the receiving station shows your ID code.

### ANSWER BACK DISPLAY

The digits to be indicated of the receiving station's answer back code can be designated. Only designated digits are indicated on the function display.

### VOICE TRANSMISSION INHIBIT

Voice transmission can be inhibited on some 5-tone memory channels.

- Only call operation can be performed.

### TIME-OUT TIMER (T.O.T.)

During continuous transmitting the transceiver automatically returns to receive when the set time-out timer period ends. And, transmission is impossible during the penalty period.

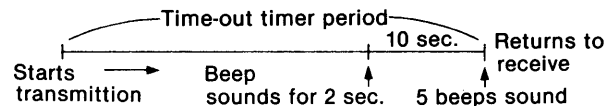

# 6

## 5-TONE OPERATION EXAMPLE

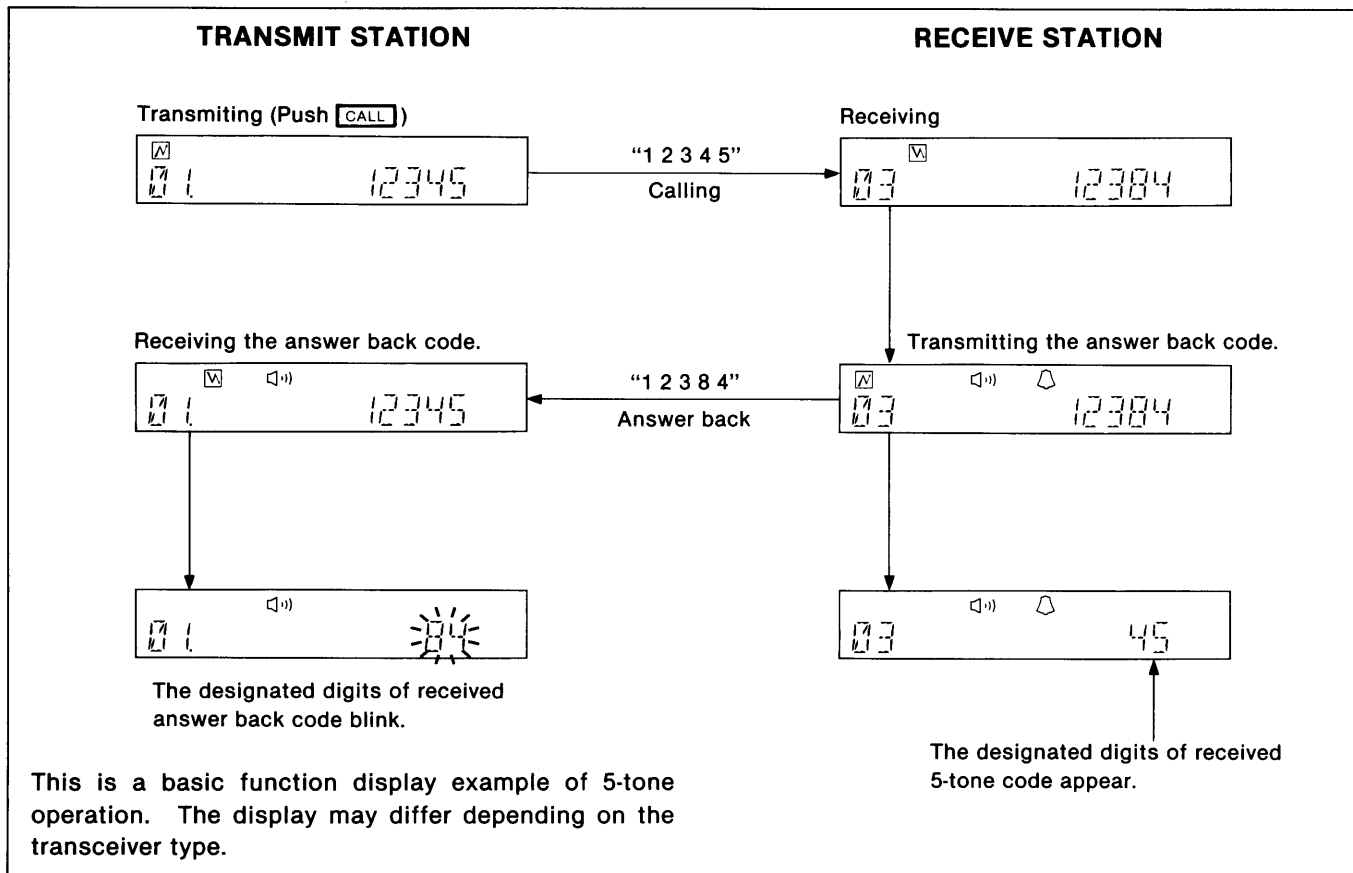

• **SP-5 EXTERNAL SPEAKER**



A large size external mobile speaker for high output power.

Max input power: 5 W  
Input impedance: 4 Ω

• **SP-10 EXTERNAL SPEAKER**

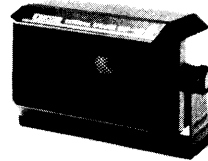

A compact size external mobile speaker.

Max input power: 5 W  
Input impedance: 4 Ω

• **SM-14 DESKTOP MICROPHONE**

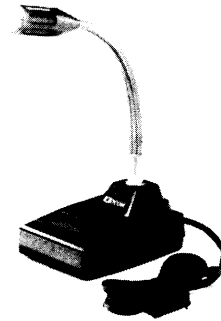

Desktop microphone equipped with a call switch.

• **EM-63 HAND MICROPHONE**

Same type as supplied with the IC-V210T/IC-U210T.

• **HM-47 DTMF MICROPHONE**

Hand microphone equipped with a DTMF encoder.

• **HS-62 MOBILE FLEXIBLE MICROPHONE+HS-62SB SWITCH BOX**

Flexible microphone for mobile operation.

• **MB-26 MOUNTING BRACKET**

Same type as supplied with the IC-V210T/IC-U210T.

• **OPC-044A DC POWER CABLE**

Same type as supplied with the IC-V210T/IC-U210T.

• **PS-200 AC POWER SUPPLY**

13.8 V DC, 8 A power supply to use the IC-V210T/IC-U210T with AC.

• **UX-11 HORN-HONK DRIVER UNIT**

This unit is necessary for connection to an external alarm device.

**Count on us!**

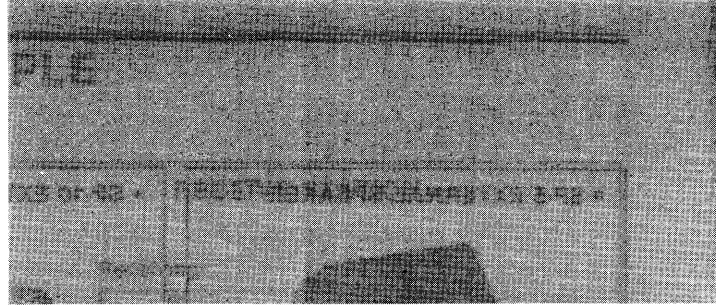

A-5169H-1EX  
Printed in Japan  
Copyright © 1991 by Icom Inc.

**Icom Inc.**  
6-9-16, Kamihigashi, Hirano-ku, Osaka 547, Japan